

BERKAY

ALÜMİNYUM SÜRGÜ & KAPAK PROFİLLERİ

CAM

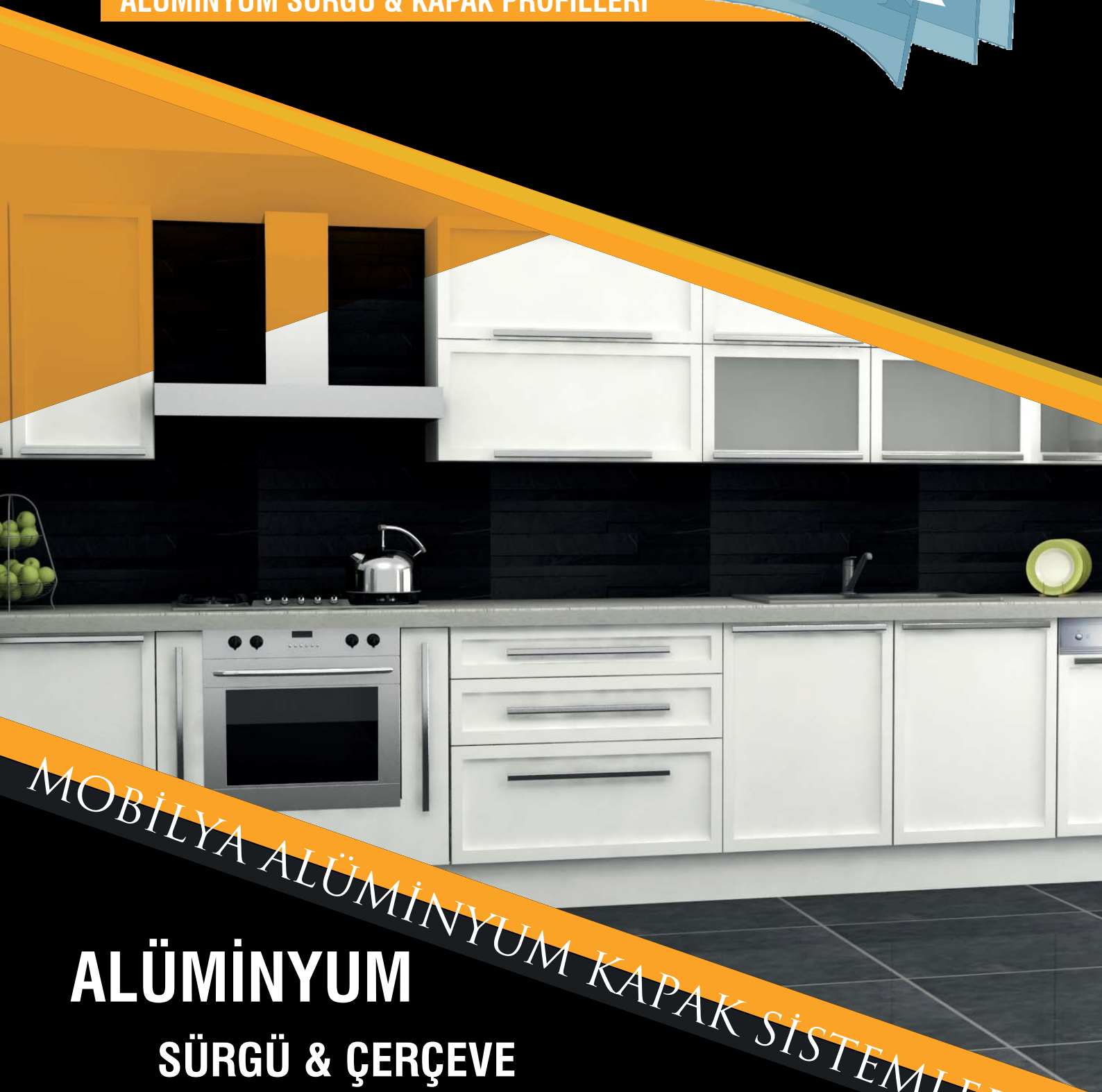

MOBİLYA ALÜMİNYUM KAPAK SİSTEMLERİ

ALÜMİNYUM

SÜRGÜ & ÇERÇEVE

KAPAK PROFİLLERİ

CAM İŞLEME



www.berkaycamaluminum.com

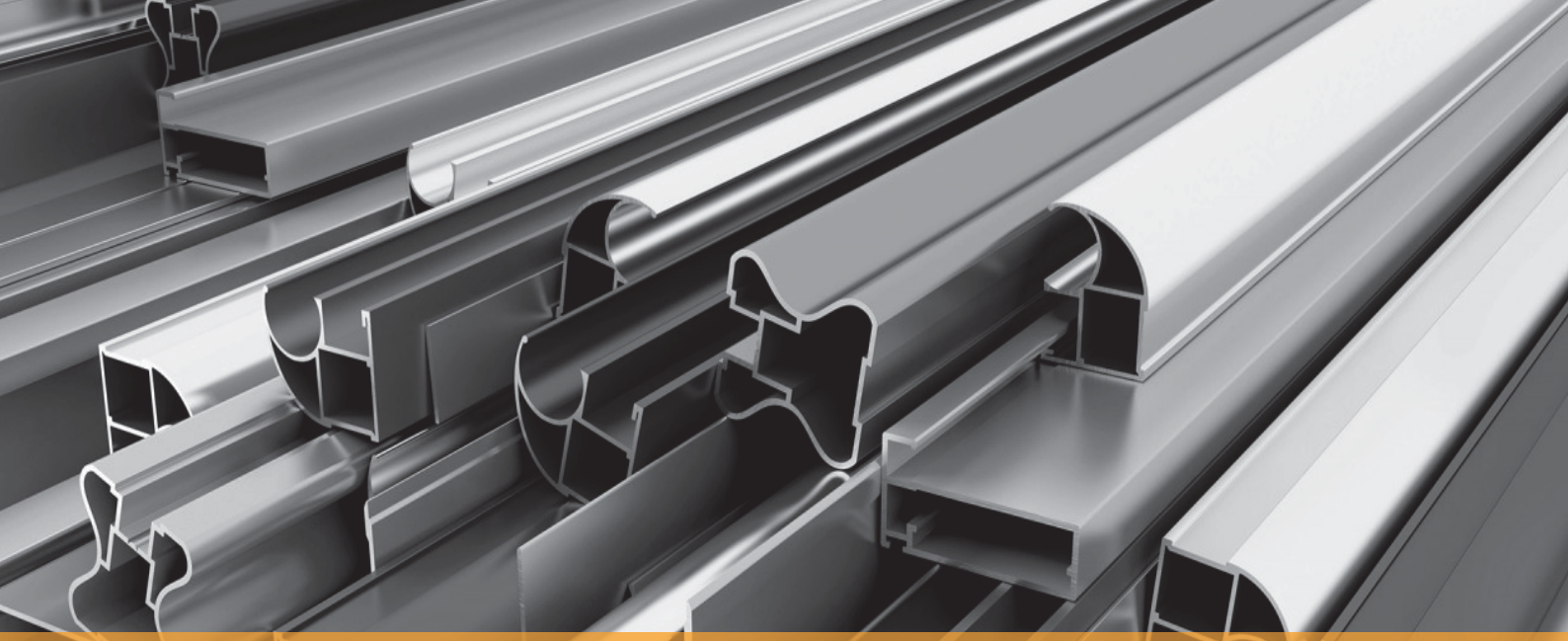

Hakkımızda

Berkay Cam 2014 Yılında Mersinde Kuruldu.

Perakende Cam ve İşleme Sektöründe Tecrübeli Kadromuzla Siz Değerli Müşterilerimize Hizmet Vermekteyiz.

Berkay Cam Daha Kaliteli Ürünler Yapmak İçin Cam, Mobilya, İnşaat Sektörünü Yakından Takip Etmiş ve Bizote, Rodaj, Formalı Rodaj, Cnc Kanal, Kumlama, Çift Kafa Kesim Delme Mobilya Alüminyum Kapak ve Sürgü Sistemleri İle Hem Müşteri Memnuniyeti Düşünmüş Hemde Sektörde Yenilikçi Olmuştur.

İş Ciddiyetini Önemseyen Bir Firma Olarak Sizlerden Aldığımız Siparişleri Sorunsuz Bir Şekilde Yerine Getiriyoruz.

Berkay Camın İlk Hedefi Daima Müşteri Memnuniyetidir, Size Her Zaman Daha İyi Hizmet Etmek Firmamızın Kapasitesini Arttırıp Çizgilerini Genişletmek ve Ülke Ekonomisine Kattıda Bulunmak İse Bizim Yegane Amacımız, Hedefimizdir.

Kalite Politikamız

Türkiye'nin Heryerine Ürünler Göndermek, Hep Birlikte Tasarladığımız, Ürettiğimiz Ürünler Hızla Çoğaldıkça Artan Gururumuz...

Asla Dürüstlük, Disiplin ve Kalite İlkelerinden Ödün Vermeden En İyisini Yapmak...

Biz Bunları Başarmaya Çalışıyoruz...

Yolumuz Daima Açık Olsun.

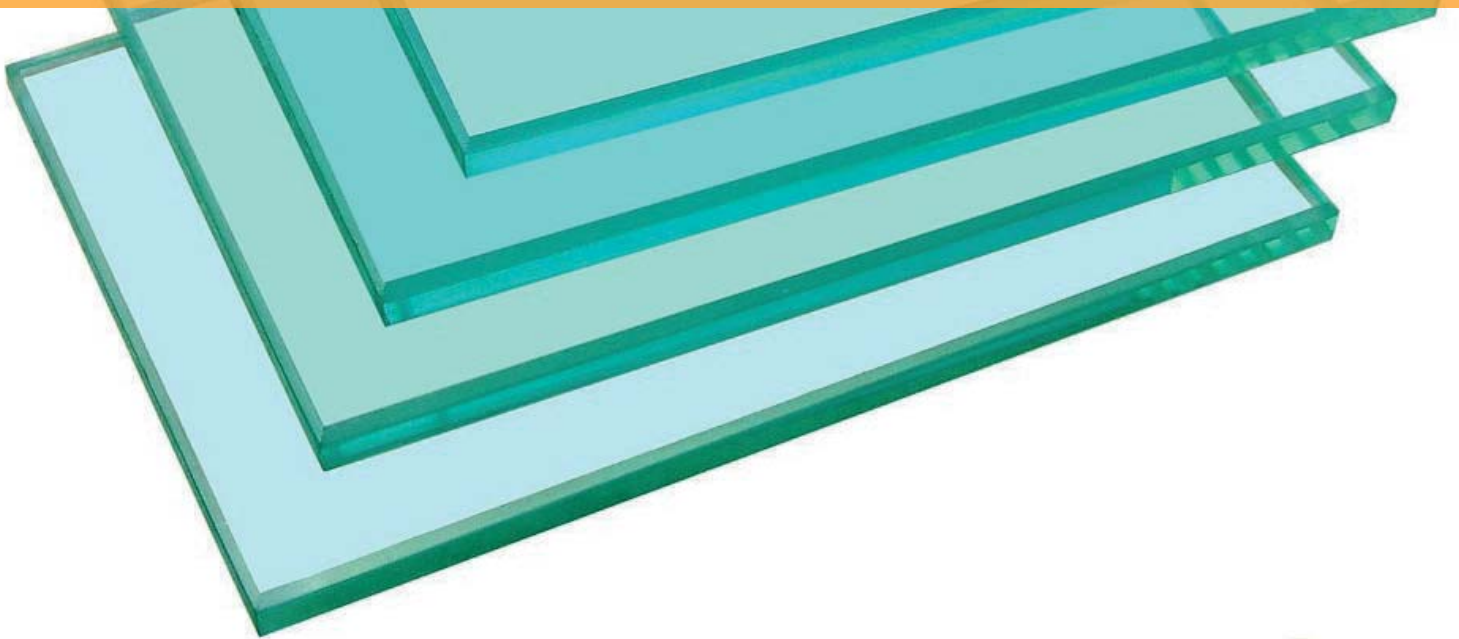

İÇİNDEKİLER / İNDEKS

Alüminyum Çerçeve Kapak Sistemleri	1-7
Alüminyum Çerçeve Kapak Aksesuarları	8
Alüminyum Sürgü Kapak Profilleri	9-13
Alüminyum Sürgü Kapak Aksesuarları	14
Alüminyum Sürgü Kapak Montaj Şeması	15
Alüminyum Sürgü Kapak Modelleri	16
Alüminyum Askı Boruları	17
Alüminyum Magaza Raf Sistemleri	18
Alüminyum Mutfak Dekorasyon Profilleri ve Aksesuarları	19
Alüminyum Baza Profilleri	20-21
Tezgah Süpürgelik ve Alın Kapama Profilleri	22
Ayarlanabilir Kapı Kasası Tezgah Altı Folyo	23
Mekanizma Grupları	24-31
Suntalam Kenar Kapama Cumba Profilleri	32-34
Tezgah Süpürgelik ve Alın Kapama Profilleri	35
Sunta Birleştirme Bitim Dönüş Derz Sistem Profilleri	36-38
Çekmece Boy Kulpları	39-46
Cam İşleme	47
Mutfak Tezgah Arası Cam Modelleri	48-49
Cam Kapı Modelleri	50
Dekoratif Ayna Modelleri	51
Makina Parkurumuz	52
Dekoratif Cam Modelleri	53-54

Mobilya Alüminyum Profilleri

Alüminyum Çerçeve Kapak Sistemleri / Aluminium Frame system profiles

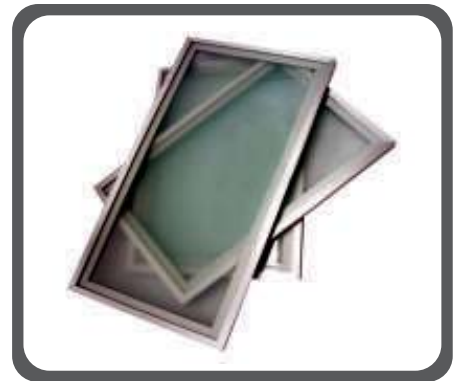
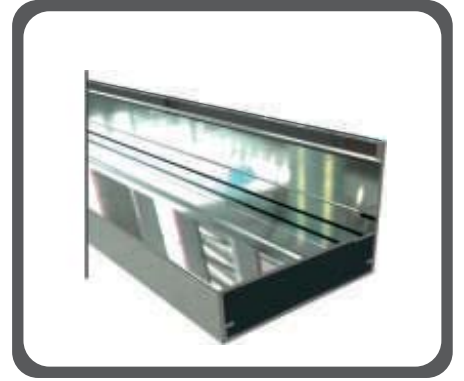
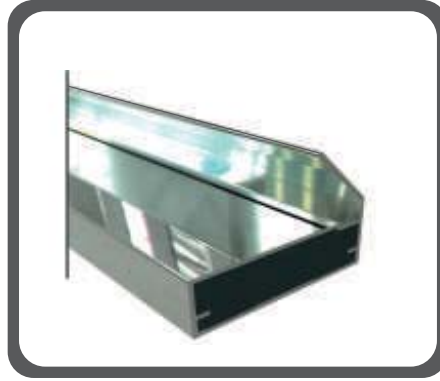

20 mm Çerçeve Kapak Sistemleri Profilleri / 20 mm Frame System Profiles

4 mm Cam / Glass
MKT 001 FTS001
PKT 001 FTY001
* MD 1002 K
ile birlikte kullanılır.

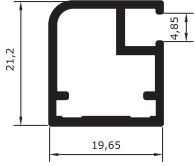

BC 1002

4 mm Cam / Glass
MKT 001 FTS001
PKT 001 FTY001
* MD 1002
ile birlikte kullanılır.

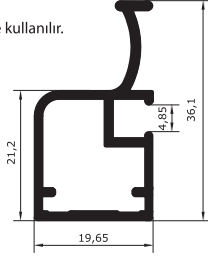

BC 1002 K

4 mm Cam / Glass
4 mm Suntalam /
Chipboard
PKT 001 FTA001
PVC köşe takozu

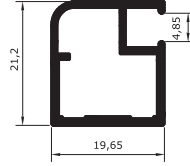

BC 1002 P

4 mm Cam / Glass
8 mm Suntalam /
Chipboard
MKT 001 FTS001
PKT 001 FTY001

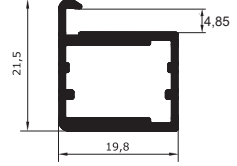

BC 1002 F

4 mm Cam / Glass
MKT 001 FTS001
PKT 001 FTY001
* MD 1002 AK
ile birlikte kullanılır.

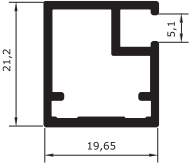

BC 1002 A

4 mm Cam / Glass
MKT 001 FTS001
PKT 001 FTY001
* MD 1002 A
ile birlikte kullanılır.

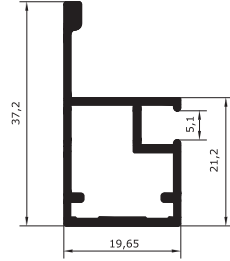

BC 1002 AK

4 mm Cam / Glass
8 mm Suntalam /
Chipboard
MKT 001 FTA001
PKT 001
* MD 1002 E
ile birlikte kullanılır

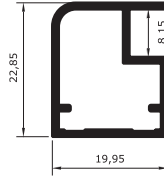

BC 1002 C

4 mm Cam / Glass
8 mm Suntalam /
Chipboard
MKT 001 FTA001
PKT 001
* MD 1002 C
ile birlikte kullanılır

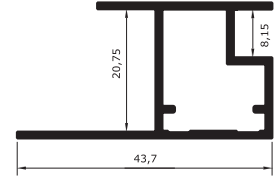

BC 1002 E

4 mm Cam / Glass
MKT 001 FTS001
PKT 001 FTY001

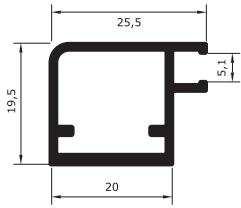

BC 1002 G

4 mm Cam / Glass
8 mm Suntalam /
Chipboard
FTA001

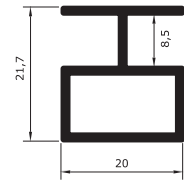

BC 1002 B

4 mm Cam / Glass
MKT 001 FTS001
PKT 001 FTY001

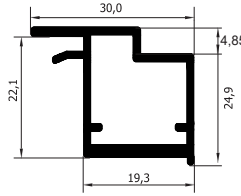

BC 1002 H

12 mm Cam /
MKT 001 FTS001
PKT 001 FTY001

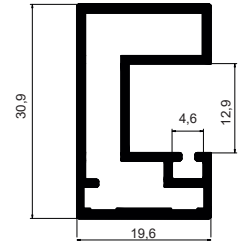

BC 1002 L



35 mm Çerçeve Kapak Sistemleri Profilleri / 35 mm Frame System Profiles

4 mm Cam / Glass
MKT 002 FTS001
FTY001

* MD 1001 CK
ile birlikte kullanılır.

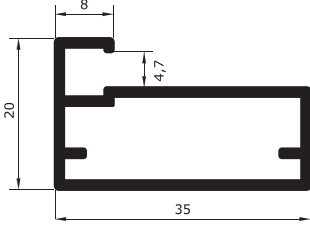

BC 1001 C

4 mm Cam / Glass
MKT 002 FTS001
FTY001

* MD 1001 C
ile birlikte kullanılır.

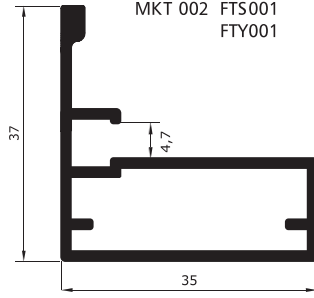

BC 1001 CK

4 mm Cam / Glass
MKT 002 FTS001
FTY001

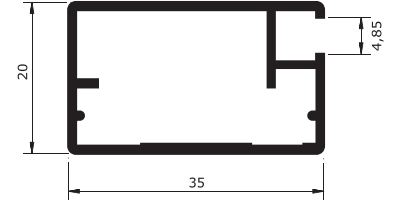

BC 1086

4 mm Cam / Glass
MKT 002 FTS001
FTY001

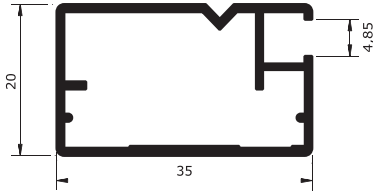

BC 1086 C

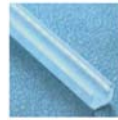
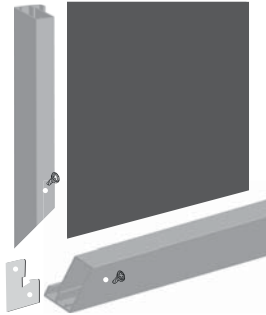

FTS 001
Fitol sert

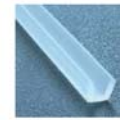

FTY 001
Fitol yumuşak

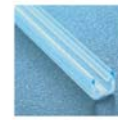

FTA 001
Fitol adaptör



MKT 004



Mini Tas M.
Düz



Mini
Süper deve



Mini Tas M.
Yarım deve

40 mm Çerçeve Kapak Sistemleri Profilleri / 40 mm Frame System Profiles

4 mm Cam / Glass
MKT 004 FTS001
FTY001

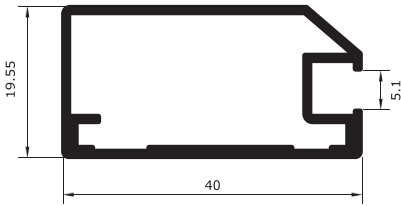

BC 1087

4 mm Cam / Glass
MKT 004 FTS001
FTY001

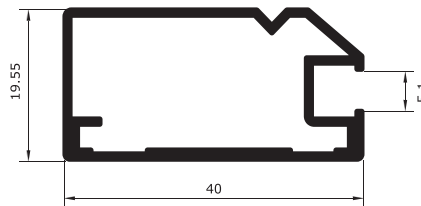

BC 1087 C

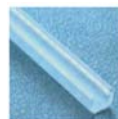
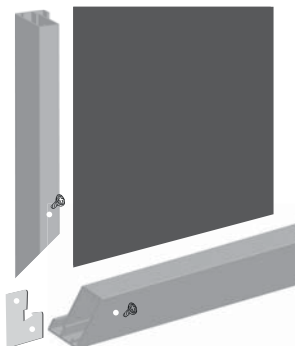

FTS 001
Fitol sert

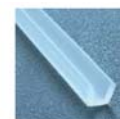

FTY 001
Fitol yumuşak

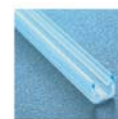

FTA 001
Fitol adaptör



MKT 004



Mini Tas M.
Düz



Mini
Süper deve



Mini Tas M.
Yarım deve

45 mm Çerçeve Kapak Sistemleri Profilleri / 45 mm Frame System Profiles

4 mm Cam / Glass
MKT 003 FTS 001
FTY 001

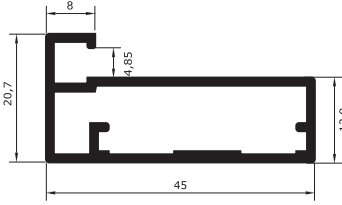

BC 1001 B

4 mm Cam / Glass
MKT 005 FTS 001
FTY 001

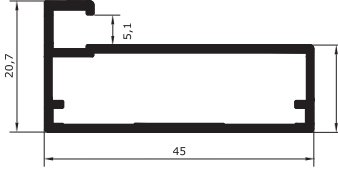

BC 1001 BY

* MD 1001 BK
ile birlikte kullanılır

* MD 1001 BY
ile birlikte kullanılır

4 mm Cam / Glass
MKT 005 FTS 001
FTY 001

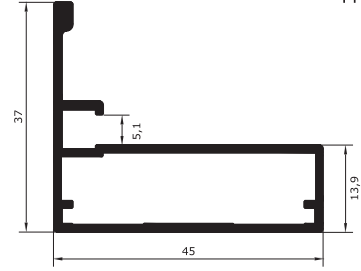

BC 1001 BK

4 mm Cam / Glass
MKT 005

* MD 1001 E ile birlikte kullanılır * MD 1001 DK ile birlikte kullanılır

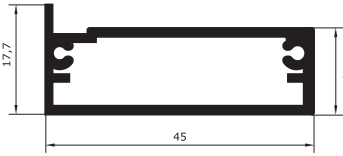

BC 1001 D

* MD 1001 D
ile birlikte kullanılır

4 mm Suntalam /
chipboard
4 mm Cam / Glass
MKT 005 FTA 001

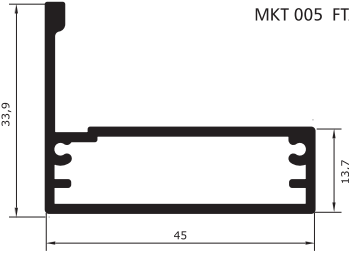

BC 1001 E

* MD 1001 D
ile birlikte kullanılır

4 mm Cam / Glass
MKT 005 FTS 001
FTY 001

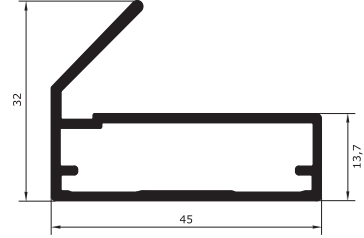

BC 1001 DK

4 mm Cam / Glass
MKT 005

* MD 1001 TK
ile birlikte kullanılır

Takmalı boy kulp

* MD 1001 T
ile birlikte kullanılır

4 mm Cam / Glass
MKT 003 FTS 001
FTY 001

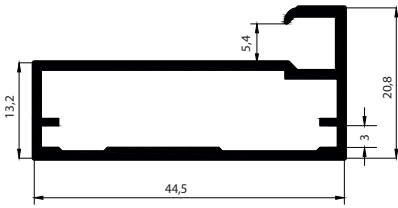

BC 1001 T

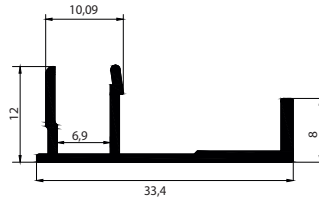

BC 1001 TK

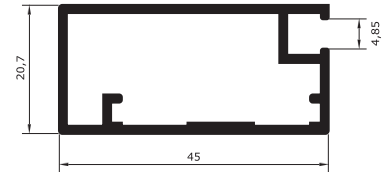

BC 1009 A

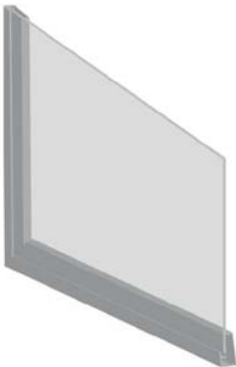

45 mm Çerçeve Kapak Sistemleri Profilleri / 45 mm Frame System Profiles

4 mm Cam / Glass
MKT 005 FTS 001
FTY 001

* MD 1001 M
ile birlikte kullanılır

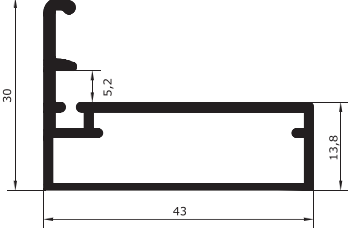

BC 1001 N

4 mm Cam / Glass
MKT 005 FTS 001
FTY 001

* MD 1001 N
ile birlikte kullanılır
* MD 1001 S
ile birlikte kullanılır

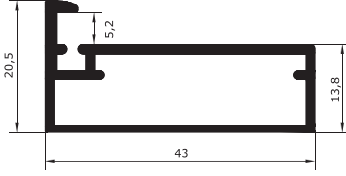

BC 1001 M

4 mm Cam / Glass
MKT 005 FTS 001
FTY 001

* MD 1001 M
ile birlikte kullanılır

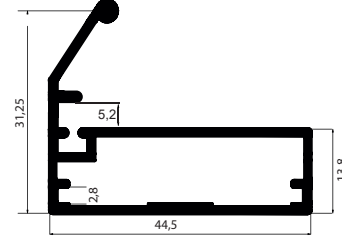

BC 1001 MK

4 mm Cam / Glass
MKT 005 FTS 001
FTY 001

* MD 1001 G
ile birlikte kullanılır

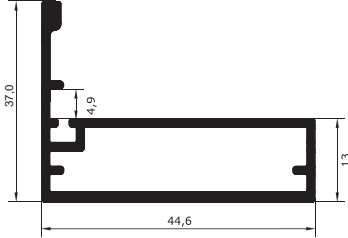

BC 1001 GK

4 mm Cam / Glass
MKT 005 FTS 001
FTY 001

* MD 1001 GK
ile birlikte kullanılır

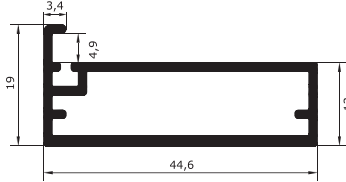

BC 1001 G

4 mm Cam / Glass
MKT 005 FTS 001
FTY 001

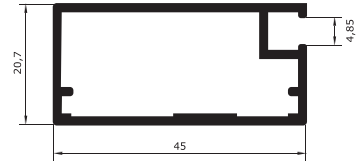

BC 1009 AY

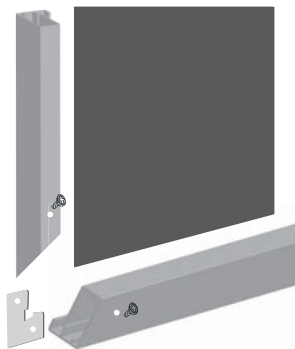

FTS 001
Filiz sert



FTY 001
Filiz yumuşak



FTA 001
Filiz adaptör



MKT 003



ZMK 001



Tas Menteşe
Düz



Tas Menteşe
Süper deve



Tas Menteşe
Yarım deve



MKT 005

45 mm Çerçeve Kapak Sistemleri Profilleri / 45 mm Frame System Profiles

4 mm Cam / Glass
MKT 003 FTS 001
FTY 001

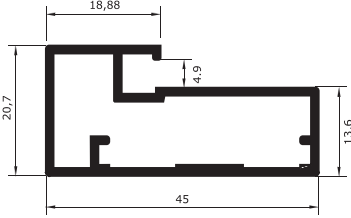

BC 1057 A

4 mm Cam / Glass
MKT 005 FTS 001
FTY 001

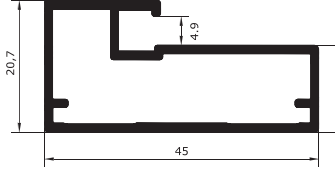

BC 1057 AY

* MD 1057 AK
ile birlikte kullanılır

* MD 1057 AY
ile birlikte kullanılır

4 mm Cam / Glass
MKT 005 FTS 001
FTY 001

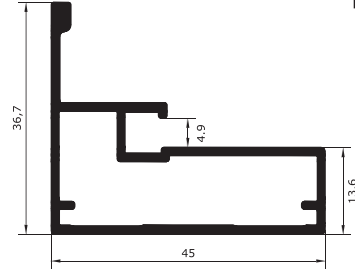

BC 1057 AK

4 mm Cam / Glass
MKT 005 FTS 001
FTY 001

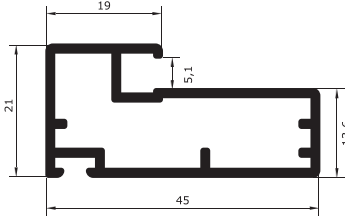

BC 1057 C

4 mm Cam / Glass
MKT 005 FTS 001
FTY 001

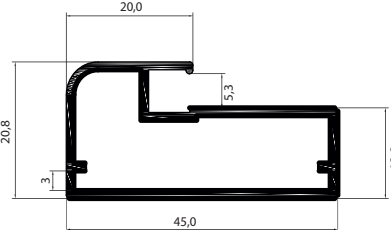

BC 1057 AR

8 mm Suntalam /
chipboard
4 mm Cam / Glass
MKT 003 FTA 001

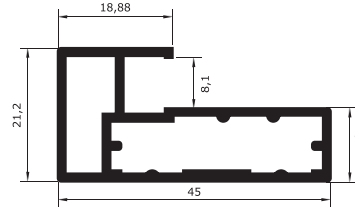

BC 1002

8 mm Suntalam /
chipboard
4 mm Cam / Glass
MKT 005 FTA 001

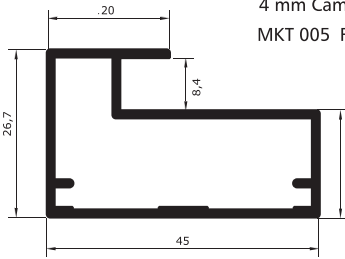

BC 1057

8 mm Suntalam /
chipboard
4 mm Cam / Glass
ZMK 001 FTA 001

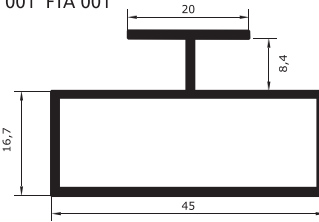

BC 1057 B

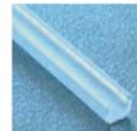
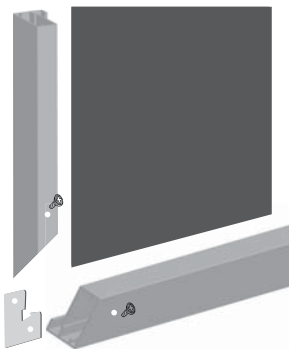

FTS 001
Fitol sert

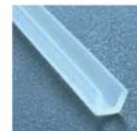

FTY 001
Fitol yumuşak

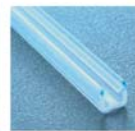

FTA 001
Fitol adaptör



MKT 003



ZMK 001



MKT 005



Tas Menteşe
Düz



Tas Menteşe
Süper deve



Tas Menteşe
Yarım deve

50 mm Çerçeve Kapak Sistemleri Profilleri / 50 mm Frame System Profiles

4 mm Cam / Glass
MKT 003 FTS001
PKT 001 FTY001

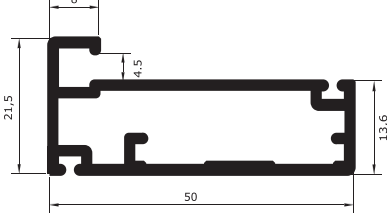

BC 1001

8 mm Suntalam /
chipboard
4 mm Cam / Glass
MKT 003 FTS 001
FTA 001 FTY 001

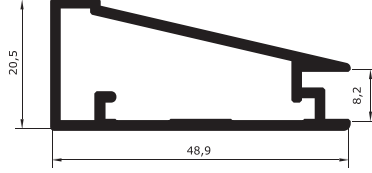

BC 1088

4 mm Cam /
MK T 003 FTS 001
FTY 001

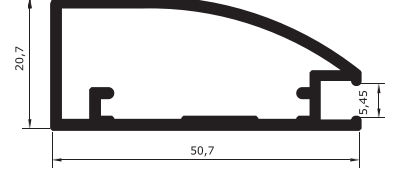

BC 1009

4 mm Cam / Glass
ZMK 001 FTS 001
FTY 001

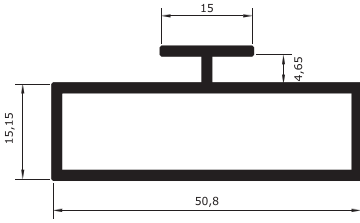

BC 1001 A



Çerçeve Kapak Dıştan Takmalı Kamalı Kulp Profilleri / Surface Mounted Frame Handle Profiles

18 mm Dıştan takmalı
kamalı kulp profili

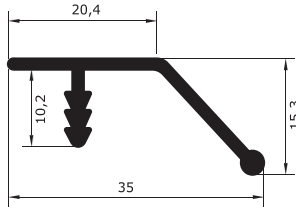

BC 1023 A

18 mm Dıştan takmalı
kamalı kulp profili

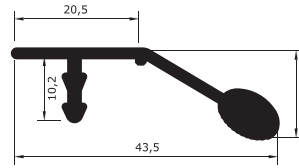

BC 1023

18 mm Dıştan takmalı
kamalı kulp profili

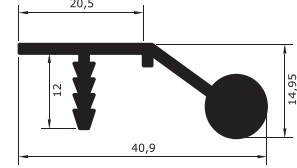

BC 1023 B

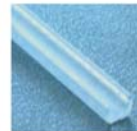
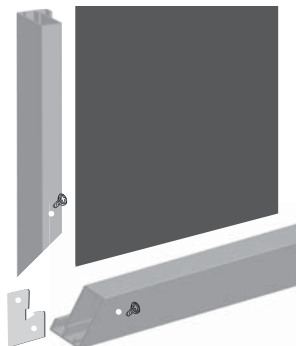

FTS 001
Fıtıl sert



FTY 001
Fıtıl yumuřak

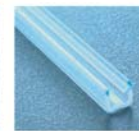

FTA 001
Fıtıl adaptör



Tas Menteře



Tas Menteře



Tas Menteře



MKT 003



ZMK 001



MKT 005

Alüminyum Çerçeve Kapak Aksesuarları / Standart Sliding Door System Profiles



Düz Menteşe

Yarım Deve Menteşe



Düz Menteşe

Yarım Deve Menteşe



Düz Menteşe

Yarım Deve Menteşe



MD 1002 **PVC** Küçük Köşe Takoğu



Süper Deve Menteşe

Menteşe Vidası



Süper Deve Menteşe

Menteşe Vidası



Süper Deve Menteşe

Menteşe Vidası



MD 1002 **METAL** Küçük Köşe Takoğu

ALÜMİNYUM ÇERÇEVE MENTEŞESİ

MİNİ TAS MENTEŞE

TAS MENTEŞE

KÖŞE BİRLEŞTİRME TAKOZU



Lüks Kırmalı Makas

BC 1002



Uzun / Kısa Gazlı Piston

BC 1002



Uzun Kılıflı Gazlı Piston

BC 1002



32 mm **METAL** Küçük Köşe Takoğu

BC 1002

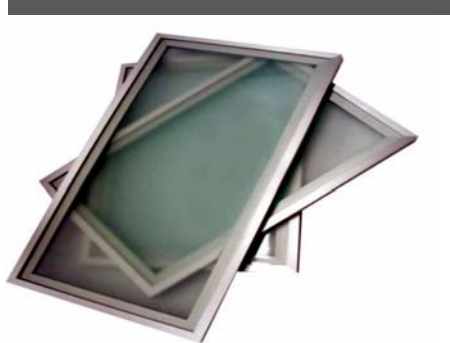

35 mm **METAL** Küçük Köşe Takoğu

KÖŞE BİRLEŞTİRME TAKOZU



U CAM FİTİLİ (YUMUŞAK)



U CAM FİTİLİ



T CAM FİTİLİ



45 mm **METAL** Küçük Köşe Takoğu

KÖŞE BİRLEŞTİRME TAKOZU

Kimyasal Parlak 8 mm Ray Kapak Sürme Sistem Profilleri / 8 mm Chemical Polish Sliding Door System Profiles

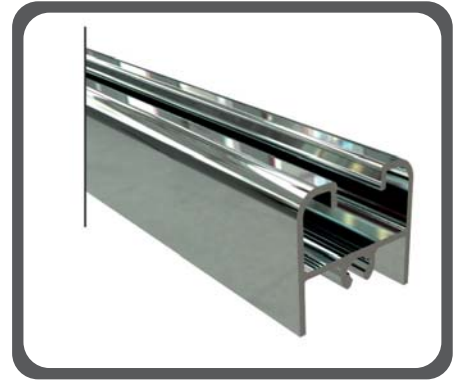
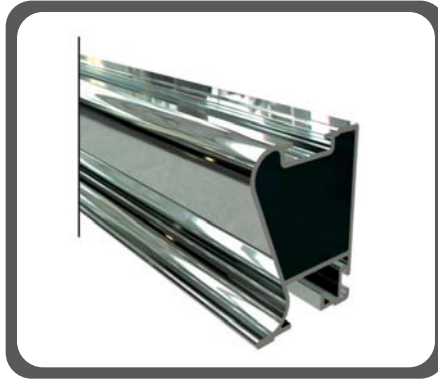
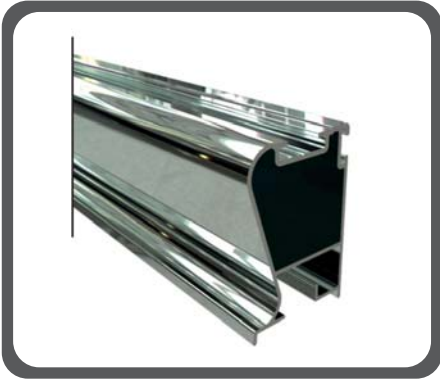

Standart Ray Kapak Sürme Sistem Profilleri / Standart Sliding Door System Profiles

8 mm Boykulp

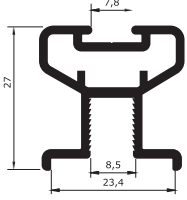

BC 1033

8 mm Boykulp

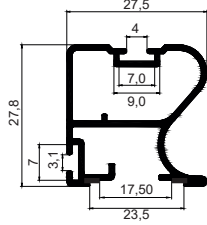

BC 2069

8 mm Boykulp

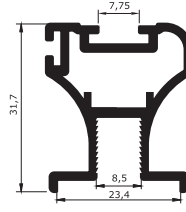

BC 2070

8 mm Boykulp

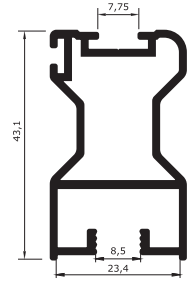

BC 2070 L

8 mm Boykulp

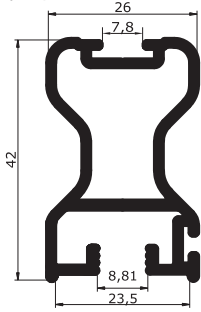

BC 2070 K

8 mm Boykulp

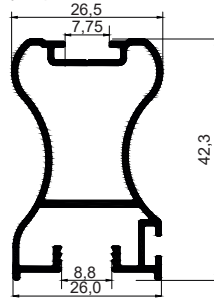

BC 2078

8 mm Boykulp

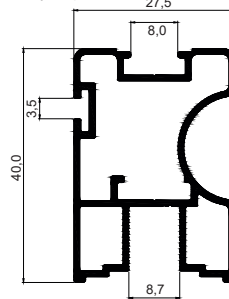

BC2074

8 mm Boykulp

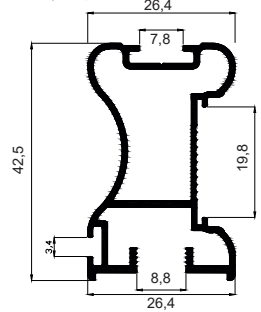

BC 2076

8 mm Boykulp

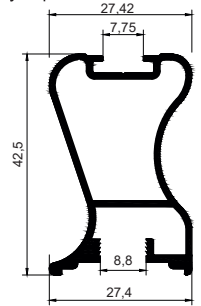

BC 2077

8 mm Boykulp

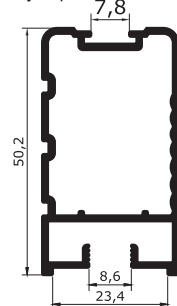

BC 2071

8 mm Boykulp

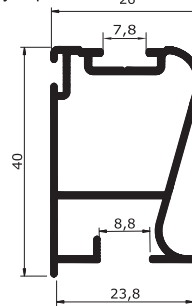

BC 2073

8 mm Boykulp

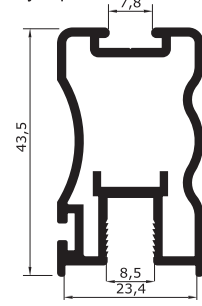

BC 2066

8 mm Ara kayıt

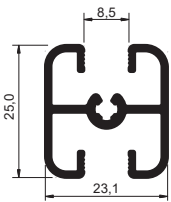

BC 1748

8 mm Üst kayıt

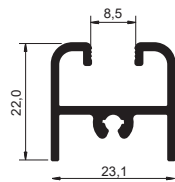

BC 1331

8 mm Çift Teker Alt Kayıt

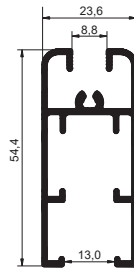

BC 1738

8 mm Tırnaklı alt kayıt

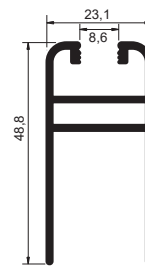

BC 1737

8 mm Vidalı alt kayıt

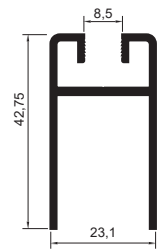

BC 1736

Çizgili Ray Kapak Sürme Sistem Profilleri / Grooved Sliding Door System Profiles

8 mm Çizgili Boykulp

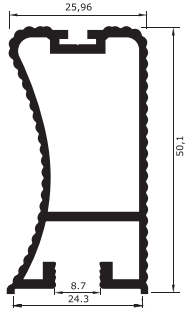

BC 1762

8 mm Çizgili ara kayıt

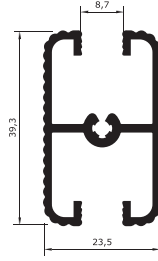

BC 1765

8 mm Çizgili üst kayıt

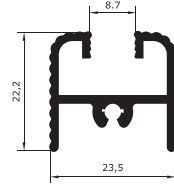

BC 1760

8 mm Çizgili vidalı alt kayıt

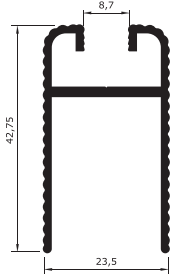

BC 1764

8 mm Çizgili üst ray

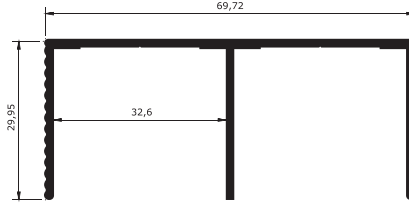

BC 1761

8 mm Alt ray

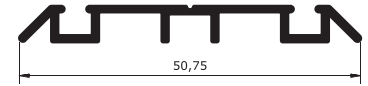

BC 1335



- * Çizgili ray dolap sisteminde profilin yüzeyleri boyuna çizgi desenlidir.
- * Çizgili yüzeyler farklılık arayan müşterilerimiz için ideal bir öneridir.
- * Mat ve parlak seçenekleri için bilgi alınız.

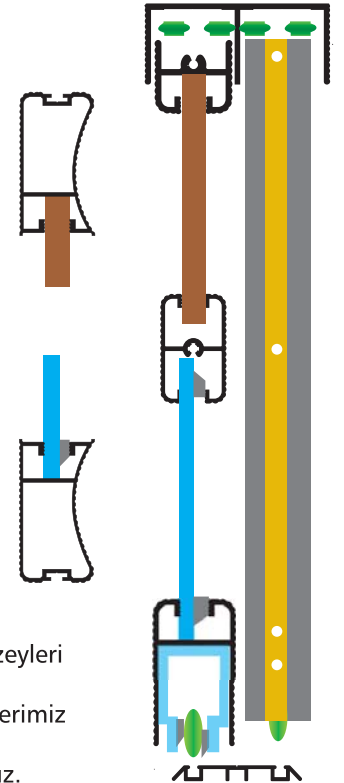

Spring Ray Kapak Sürme Sistem Profilleri / Spring Sliding Door System Profiles

8 mm Boykulp

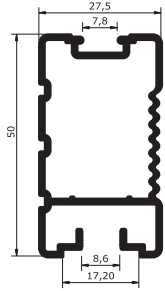

BC 2071 A

8 mm Boykulp

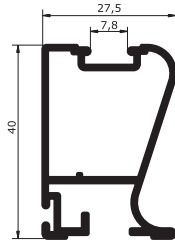

BC 2072

8 mm Boykulp

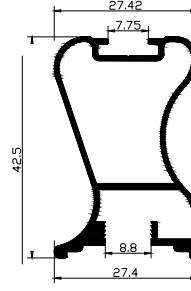

BC 2077

8 mm Boykulp

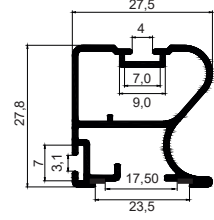

BC 2069

8 mm Boykulp

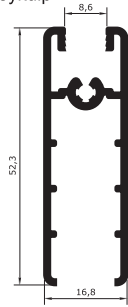

BC 1735

8 mm Boykulp

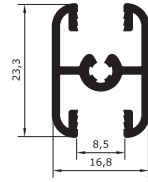

BC 1749

8 mm Boykulp

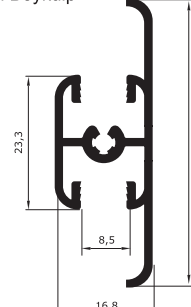

BC 1749

8 mm Boykulp

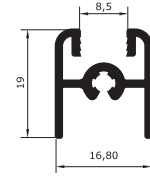

BC 1332

8 mm Boykulp

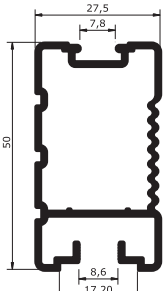

BC 2071 A

8 mm Boykulp

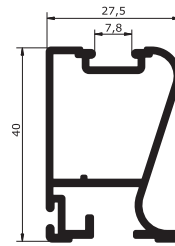

BC 2072

8 mm Boykulp

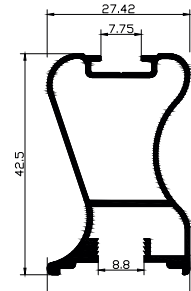

BC 2077

8 mm Boykulp

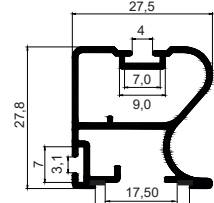

BC 2069

8 mm Ara kayıt

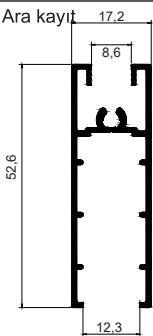

BC 1735 A

8 mm Üst kayıt

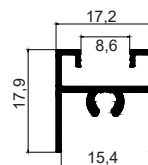

BC 1333

8 mm Ara kayıt

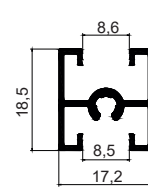

BC 1750

8 mm Geniş ara kayıt

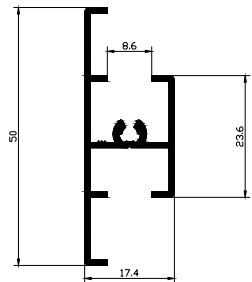

BC 1750 A

Yeni Ray Kapak Sürme Sistem Profilleri / New Sliding Door System Profiles

18 - 8 mm Boykulp

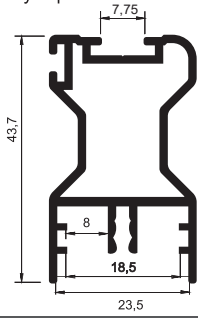

BC 2080 L

18 - 8 mm Boykulp

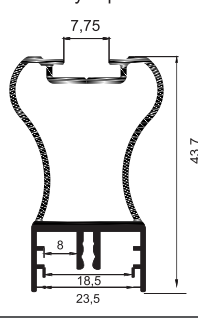

BC 2088

18 - 8 mm Boykulp

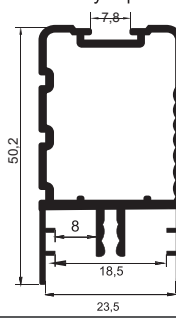

BC 2081



18 - 8 mm Üst kayıt

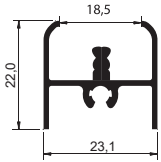

BC 2331

18 - 8 mm Ara kayıt

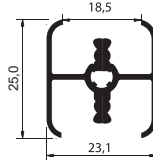

BC 2748

18 - 8 mm
Çift teker alt kayıt

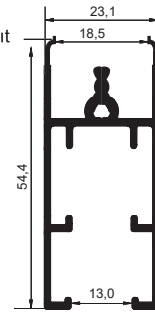

BC 2738

18-8 mm Üst ray

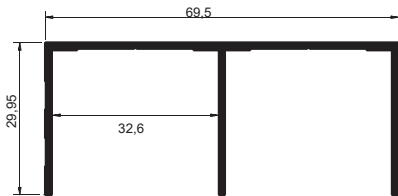

BC 1334/3

18-8 mm Altt ray

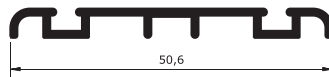

BC 1335 A

18-8 mm Alt ray



BC 1335 B

18-8mm Üst ray

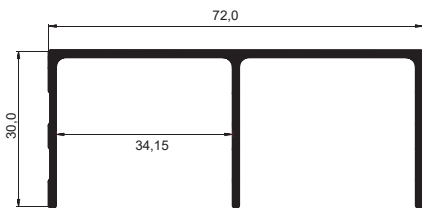

BC 1334 / 4

18-8mm Kapaklı altt ray

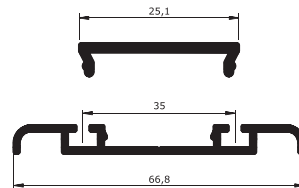

BC 1335 C

18-8 mm Alt ray kapak

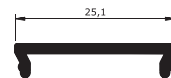

BC 1335 CK

Ray Kapak Mekanizmaları - Yavaşlatıcılar ve Aksesuarlar / Rail Cover Mechanisms - Slowers & Accessories

Beta



Durdurucu yaprak yay

Paket 100 metre
Renk
Mat
Inox
Parlak



Paket 100 metre
Renk
Mat
Inox
Parlak



Paket 100 metre
Renk
Mat
Inox
Parlak



PKM 80 İÇ BÜKEY TIRNAKLI

KALIN ÇARPMA FİTİLİ

İNCE ÇARPMA FİTİLİ

İNCE ÇİZGİLİ ÇARPMA FİTİLİ

Gama



Paket 250 metre



Paket 100 metre



Paket 100 metre



PKM 80 İÇ BÜKEY VİDALI

TOZ KIL FİTİLİ

DOLGU CAM FİTİLİ

E CAM FİTİLİ

DURDURUCU YAPRAK YAY



PASLANMAZ KASA



PASLANMAZ KASA



PVC KASA



PKM 83 DİŞ BÜKEY ÇİFT TEKER

8 mm UZUN LÜKS FREN SİSTEMİ

8 mm KISA LÜKS FREN SİSTEMİ

8 mm EKO FREN SİSTEMİ

DURDURUCU YAPRAK YAY



DURDURUCU YAPRAK YAY



PKM 83 DİŞ BÜKEY TEK TEKER

PKM 81 DİŞ BÜKEY MİNİ TEKER

PKM 84 YAYLI ÜST KLAVUZ

PKM 85 MİNİ VEGA TEKER

Standart Ray Kapak Sürme Sistem Profilleri



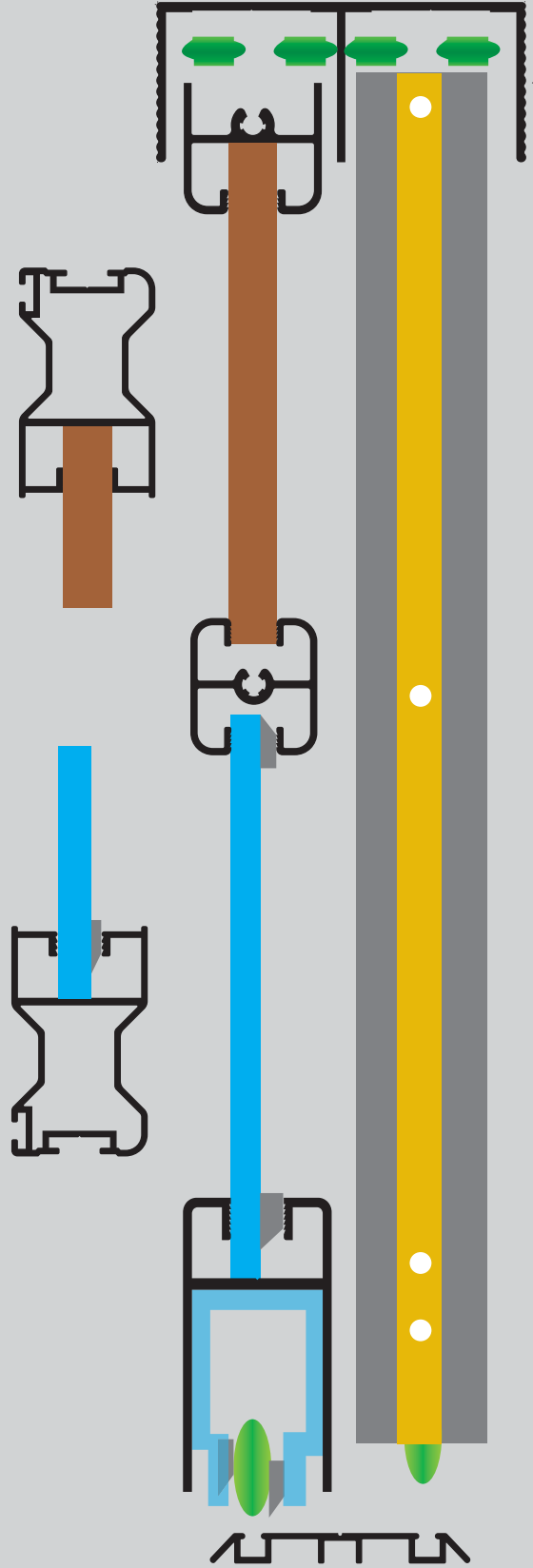



/ Standart Sliding Door System Profiles

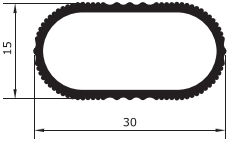
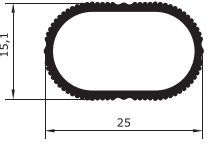
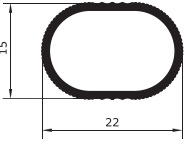
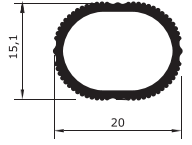
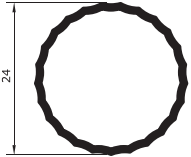
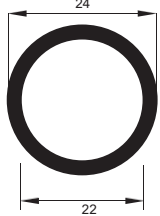
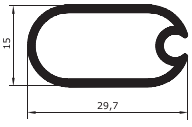
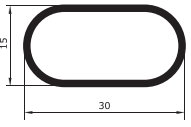
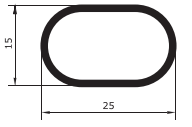
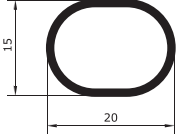
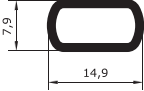

Sürgü Modelleri



Alüminyum Askı Boruları / Aluminium Hanger Rods

15 x 30 çizgili oval askı borusu	15 x 25 çizgili oval askı borusu	15 x 22 çizgili oval askı borusu	15 x 20 çizgili oval askı borusu	22 x 24 çizgili yuvarlak askı borusu	22 x 24 Düz yuvarlak askı borusu
					
BC 1017 A	BC 1017 E	BC 1017 CA	BC 1017 C	BC 1017 F	BC 1017 FA
15 x 30 Düz fitilli oval askı borusu	15 x 30 Düz oval askı borusu	15 x 25 Düz oval askı borusu	15 x 20 Düz oval askı borusu	7,9 x 15 Düz yuvarlak pantolonluk borusu	Zamak askı Flaşı Paket 500 adet
					
BC 1017	BC 1017 L	BC 1017 D	BC 1017 B	BC 1017 G	ASKI FLANŞI
12 x 10 Düz yuvarlak pantolonluk borusu	10 x 8 Düz yuvarlak pantolonluk borusu	10 x 8 Çizgili yuvarlak pantolonluk borusu	8 x 6 Düz yuvarlak pantolonluk borusu		
					
BC 1103 B	BC 1103 A	BC 1103	BC 1001		

Alüminyum Led Askı Profilleri ve Boruları / Led Aluminium Profiles And Suspended

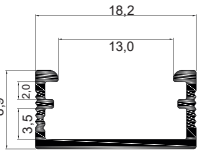
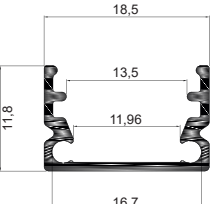
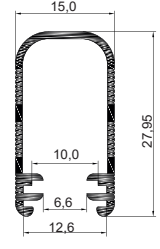
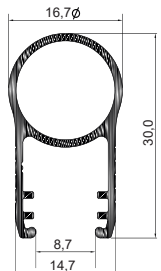
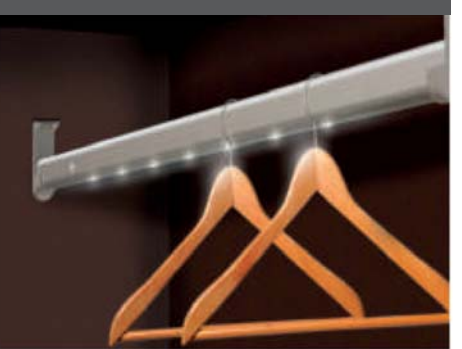
				
BC 0001	BC 0002	BC 1017 H	BC 1001	

Magaza Raf - Stand Dekorasyon Sistem Profilleri / Decorational System Profilleri For Store, shelves & Stands

Kanalı tel askılık profili

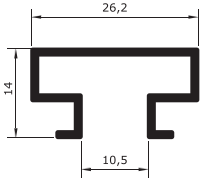

BC 0064

Kanalı tel askılık profili

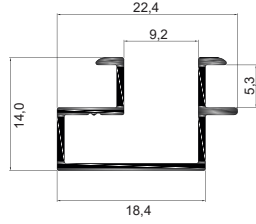

BC 0048

Kanalı tel askılık profili

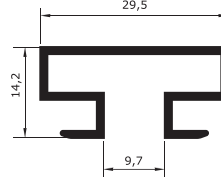

BC 0049

Kanalı tel askılık profili

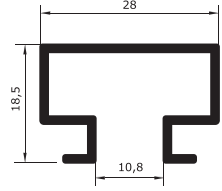

BC 0049 A

Kanalı tel askılık profili
(Tırnaksız)

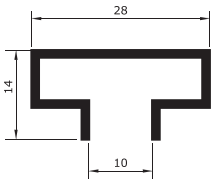

BC 0043

Kanalı tel askılık profili
(Tırnaksız)

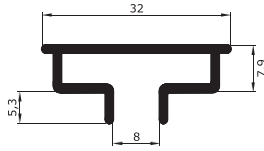

BC 0044

Kanalı tel askılık profili

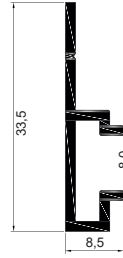

BC 0045

Krom galvaniz
*Askı kancası
ölçüleri:

- 5 cm
- 10 cm
- 15 cm
- 20 cm
- 25 cm
- 30 cm



ASKI KANCASI

Kanalı çiftli dikme profili

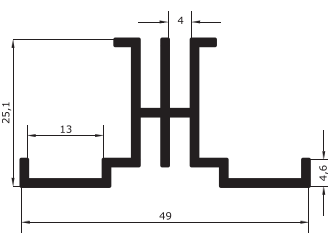

BC 0050

Kanalı tekli dikme profili

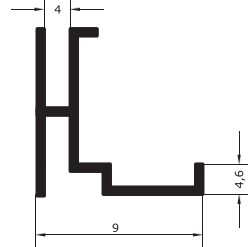

BC 0050 A

Kanalı çiftli dikme profili

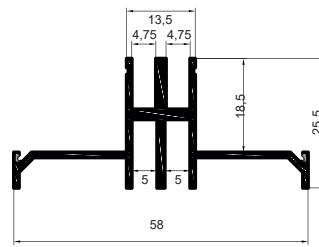

BC 0051

Borulu	Borusuz
200 mm	200 mm
250 mm	250 mm
300 mm	300 mm
350 mm	350 mm
400 mm	400 mm

KROM HARF KOLU



Mutfak Dekorasyon Profilleri ve Aksesuarları / Kitchen Decoration Profiles & Accessories

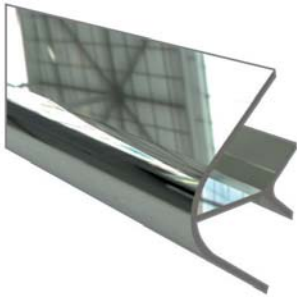
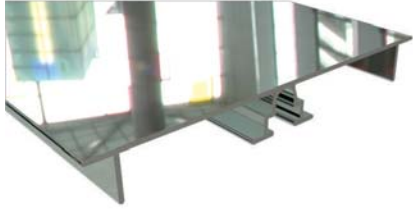

PVC Alüminyum
Baza Ayağı



Baza Fitili

Baza Ayak
Klipsi

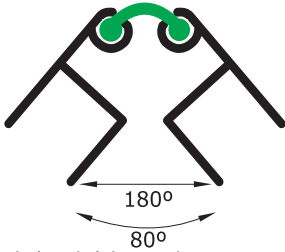

Hareketli (multi) baza dönüş uygulaması

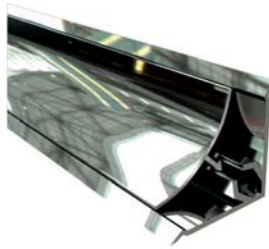

MD 1030 DK



Modül Bağlantı
Aparatı



MD 1030 DK



Dekoratif Alüminyum Baza Profilleri / *Decorational Functional Base Profiles*

100 mm çizgili
Tezgah altı baza profili

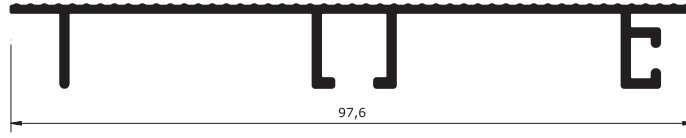

BC 1013

100 mm kalın çizgili
Tezgah altı baza profili

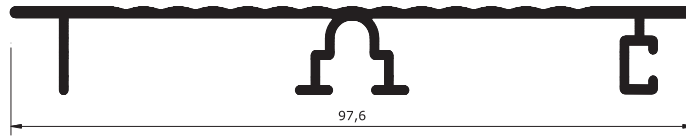

BC 1013 C

100 mm Düz
Tezgah altı baza profili

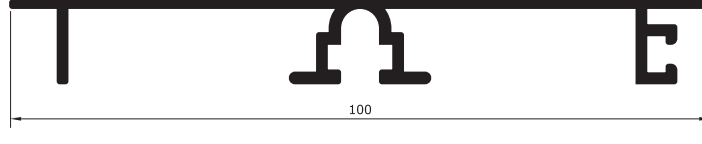

BC 1013 A

120 mm çizgili
Tezgah altı baza profili

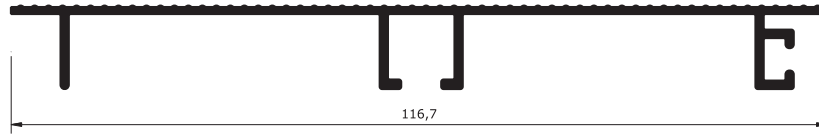

BC 1014

120 mm kalın çizgili
Tezgah altı baza profili

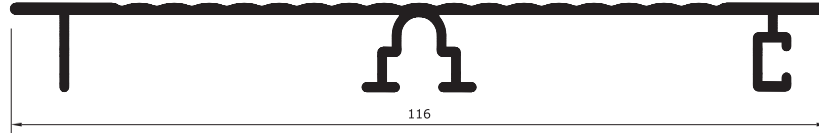

BC 1014 C

120 mm Düz
Tezgah altı baza profili

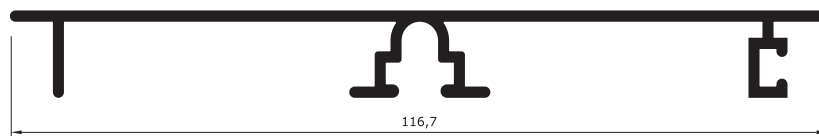

BC 1014 A

Alüminyum Baza Profilleri / Decorational & Functional Base Profiles

150 mm çizgili
Tezgah altı
baza profili

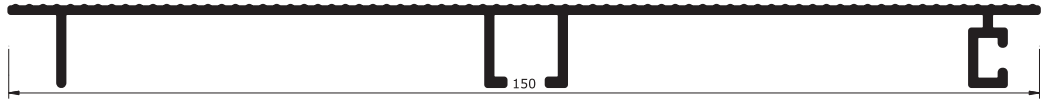

BC 1059

150 mm çizgili
Tezgah altı
radüslü
baza profili

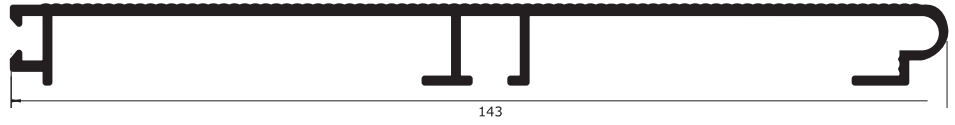

BC 1059 A

150 mm
Kalın Çizgili
Tezgah altı
baza profili

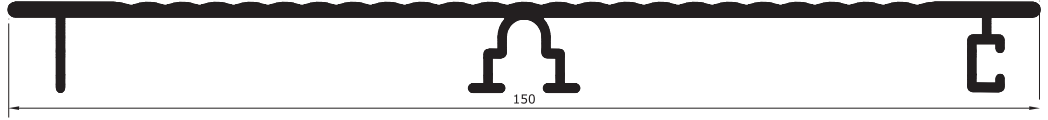

BC 1059 Ç

150 mm çizgili
Tezgah altı
baza profili

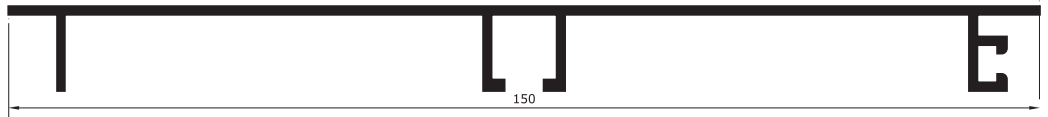

BC 1060

90° baza Köşe
dönüş profili

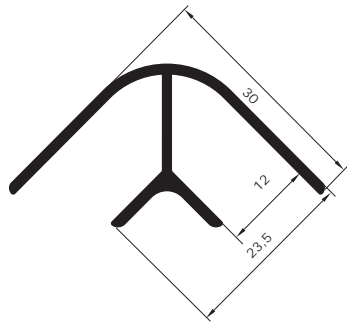

BC 1015

Baza bitiş profili

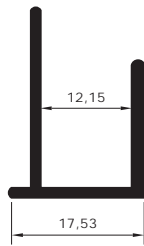

BC 1126

135° baza
Köşe dönüş
profili

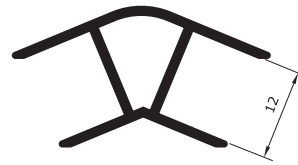

BC 1016

Hareketli baza
Dönüş Profili

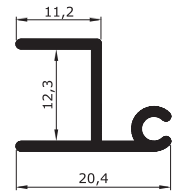

BC 1015 A

* Baza fitili ve baza klipsi isteyiniz

Tezgha Süpürgelik ve Alın Kaplama Profilleri / Countertop Skirting and Face Coating Profiles

Oval düz tezgha süpürgeliği

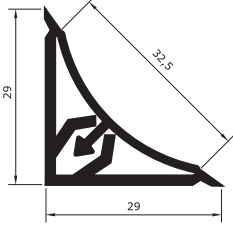

BC 1011

Oval çizgili tezgha süpürgeliği

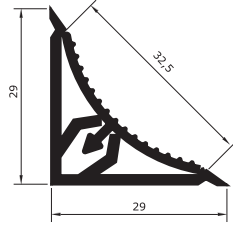

BC 1054

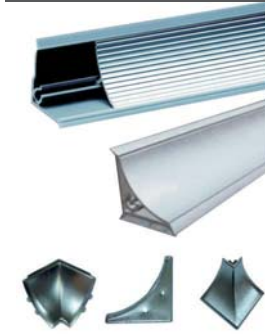

Düz çizgili tezgha süpürgeliği

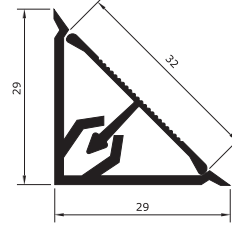

BC 1011 A

Düz tezgha süpürgeliği

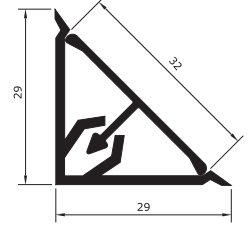

BC 1011 B

Modül bağlantı profili

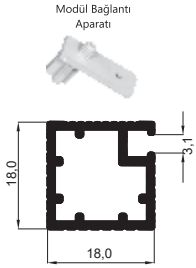

BC 1053

Modül bağlantı profili

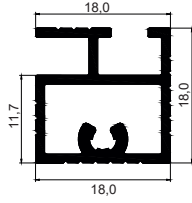

BC 1053 B

Birleştirme çitası



BC 1072

Birleştirme çitası

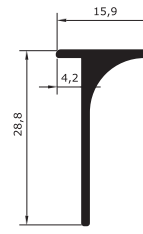

BC 1073

Çizgili tezgha kapağı

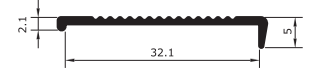

BC 1094

35 mm radüslü tezgha alın profili

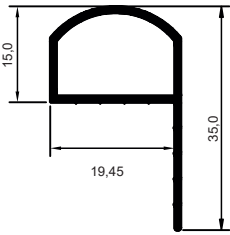

BC 1030 C

35 mm radüslü tezgha alın profili

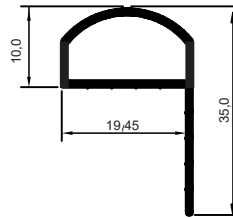

BC 1030 CA

35 mm radüslü tezgha alın profili

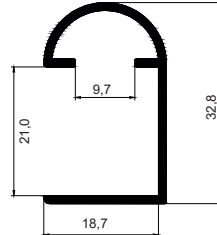

BC 1030 CB

Damlalıklı (düz tabanlı tezghalar)



Oval tabanlı tezghalar



40 mm Damlalıklı (düz tabanlı tezghalar)



Tezgha Ara Birleştirme Profilleri / Counter Joint Profiles

40 mm radüslü tezgha alın profili

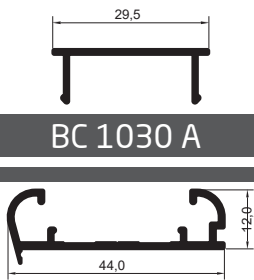

BC 1030 A

BC 1030

60 mm radüslü tezgha alın profili

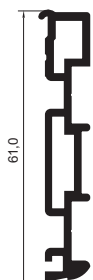

BC 1032 A

60 mm radüslü tezgha alın profili



BC 1032

60 mm radüslü tezgha alın profili

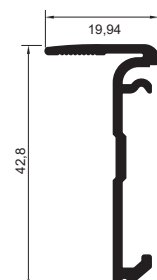

BC 1031

60 mm radüslü tezgha alın profili



BC 1031 A

Ayarlanabilir Kapı Kasası Profilleri / Adjustable Door Frame Profiles

Kapı ana kasa profili

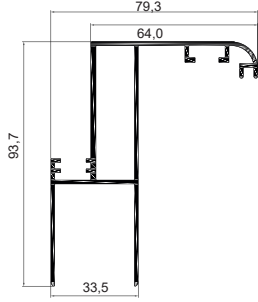

BC 1001

Kapı kasası
ara bağlantı profili

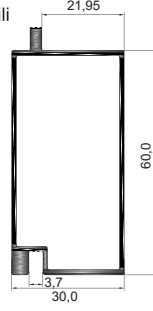

BC 1002

9 - 12 Pervaz profili

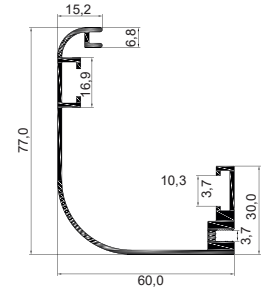

BC 1003

12 - 15 Pervaz profili

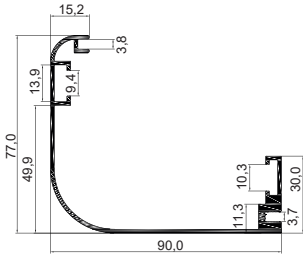

BC 1004

15 - 18 Pervaz profili

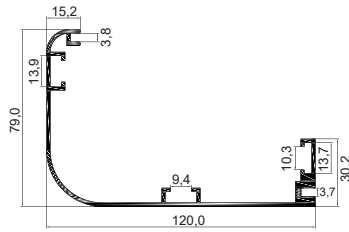

BC 1005

18 - 21 Pervaz profili

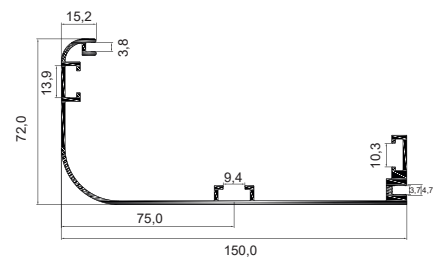

BC 1006

42 mm Suntalam / chipboard

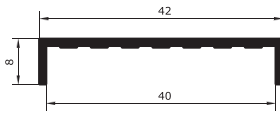

BC 1122 D

42 mm Suntalam / chipboard

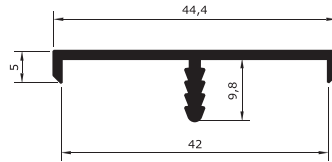

BC 1043

42 mm Suntalam / chipboard

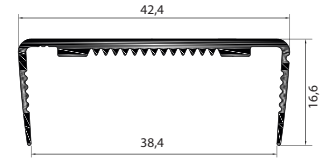

BC 1122 F



İstenilen desenlerde üretim yapılabilir

ALÜMİNYUM GOFRAJLI LEVHA

50 cm
60 cm
70 cm
80 cm
90 cm
100 cm
110 cm

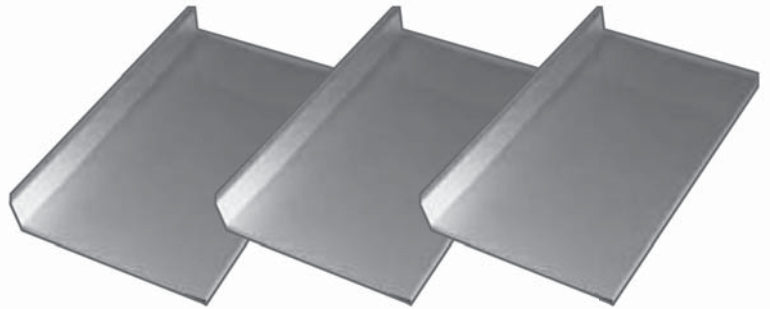

ALÜMİNYUM TEZGAH ALTI KORUMA FOLYOLARI

SKM 15 E PVC Üst Klavuzlu Sürme Hafif Sistem Ray Kapak Mekanizması / Mechanism Groups



Üst durdurucu



SKM 15-E mekanizma



SKM 15-E Alt makara

Tekli Alt ray

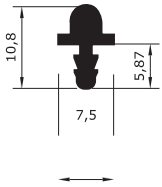

BC 1049

Tekli Alt ray

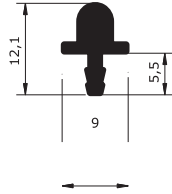

BC 1049 B

Tekli Alt ray

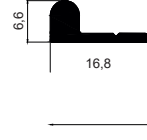

BC 1049 D

- * 30 kg ağırlığındaki sürgü kapaklarda kullanılır.
- * Alüminyum çerçeveli kullanımlarda sistem çerçeve üzerine monte edilir.
- * Ahşap ve Alüminyum çerçeveli kapaklara uyumludur.

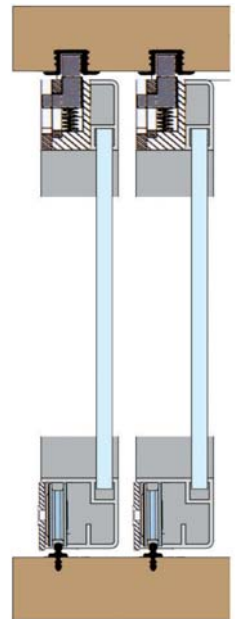

Tekli üst ray (PVC)

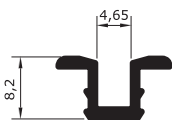

BC 1734 B



CSS 30 Camlı Sistem Ray Kapak Mekanizması / Mechanism Groups

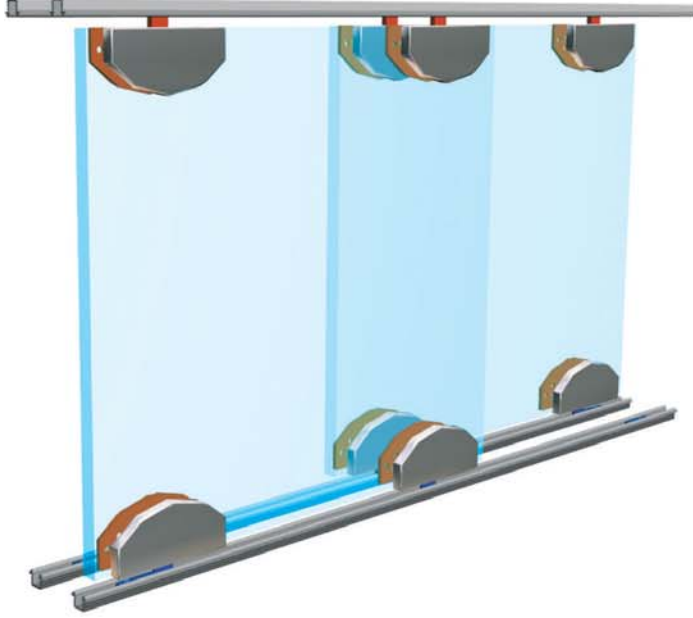

CSS 30 Mekanizma

Tekli Alt - Üst ray

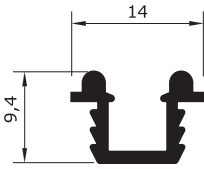

- * Maksimum 30 kg ağırlığındaki sürgü kapaklarda kullanılır.
- * Alüminyum profil içinde çalışan rulmanlı makaralardan oluşur.
- * Diğer tüm sürme camlı kapaklarla uyumludur.
- *Yükseklik ayarlanabilir makaralara sahiptir.

BC 0083

CSS 30 Mekanizma

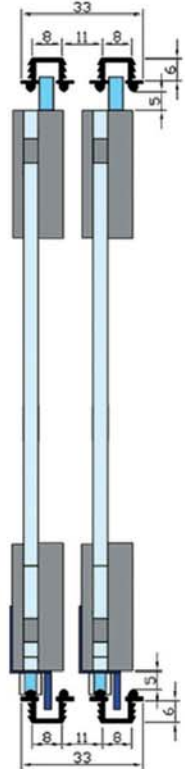
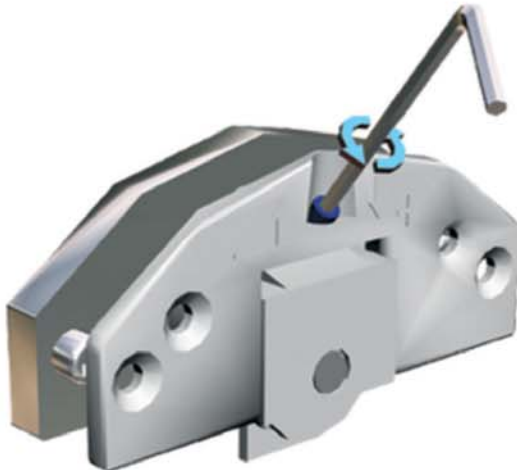

PNS 75 TM Tek Makaralı Sistem Ray Kapak Mekanizması / Mechanism Groups



Yavaşlatıcı



Durdurucu



Tek makara

Çiftli Alt - Üst ray

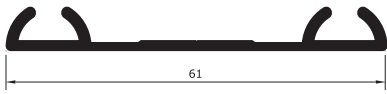

BC 1120

Çiftli Alt - Üst ray

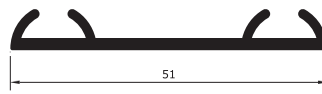

BC 1120 A

Çiftli Alt - Üst ray

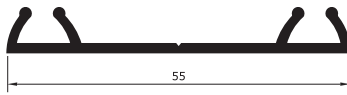

BC 1020 B

Çiftli Alt - Üst ray

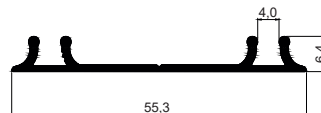

BC 1020 F

Çiftli Alt - Üst ray

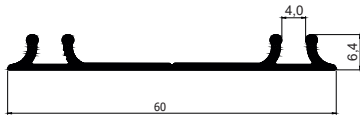

BC 1120 G

Tekli Alt - Üst ray



BC 1119

Tekli Alt - Üst ray

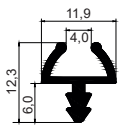

BC 1119

Tekli Alt - Üst ray

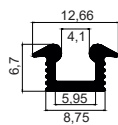

BC 1734 D

Tekli Alt - Üst ray

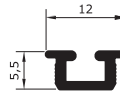

BC 1734 C

- * Max. 75 kg ağırlığındaki sürgü kapaklarda kullanılır.
- * Kapak hareketi ve kılavuzlaması aynı makara ile sağlanır.
- * Kapakların kalınlığına göre tekli ve çiftli alüminyum ray seçenekleri mevcuttur.
- * 16-18-20-22 mm kalınlıklarındaki sunta kapaklara uygulanabilir.
- * Alt mekanizma poliamid kaplı çelik rulman tekeri ile çalışır.

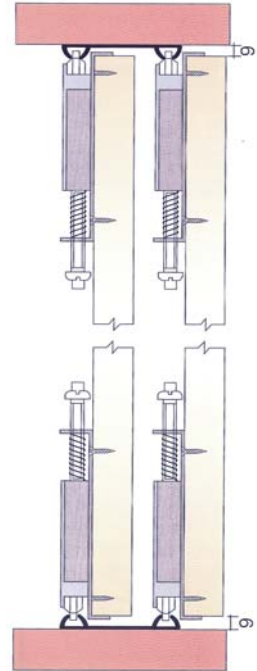

PNS 75 E Metal Klavuzlu Sistem Ray Kapak Mekanizması / Mechanism Groups

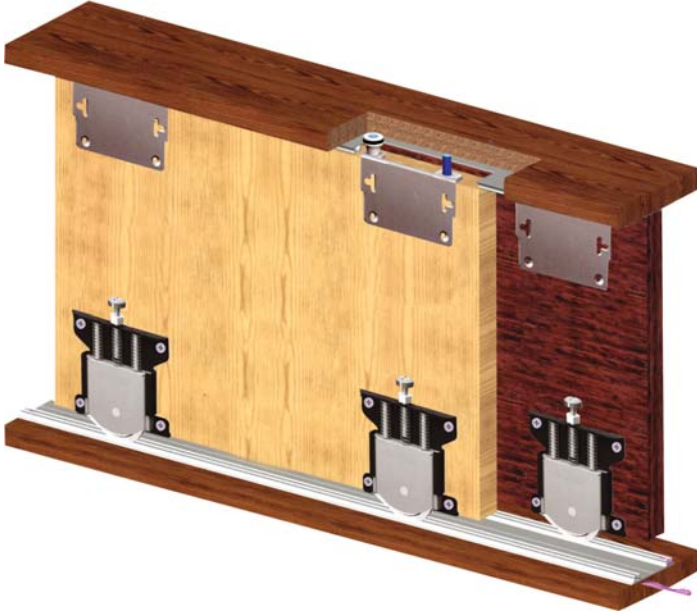

PNS 75 E
Metal klavuz



Yavaşlatıcı



Durdurucu



PNS 75 makara



Durdurucu

Çiftli Alt - Üst ray

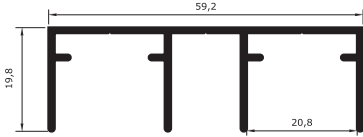

BC 1070

Çiftli Alt - Üst ray

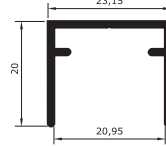

BC 1070 B

Çiftli Alt - Üst ray

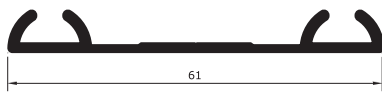

BC 1120

Çiftli Alt - Üst ray



BC 1120 B

Çiftli Alt - Üst ray

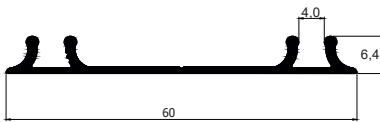

BC 1120 F

Tekli Alt - Üst ray

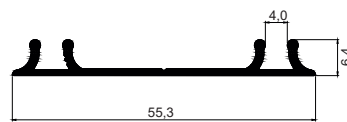

BC 1120 G

Tekli Alt - Üst ray

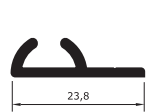

BC 1119

Tekli Alt - Üst ray

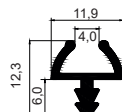

BC 1119 A

Tekli Alt - Üst ray

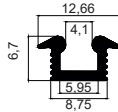

BC 1734 D

Tekli Alt - Üst ray

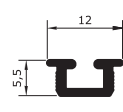

BC 1734 C

- * Max. 75 kg ağırlığındaki sürgü kapaklarda kullanılır.
- * Kapakların kalınlığına göre tekli ve çiftli alüminyum ray seçenekleri mevcuttur.
- * 16-18-20-22 mm kalınlıklarındaki sunta kapaklara uygulanabilir.
- * Alt mekanizma poliamid kaplı çelik rulman tekeri ile çalışır.

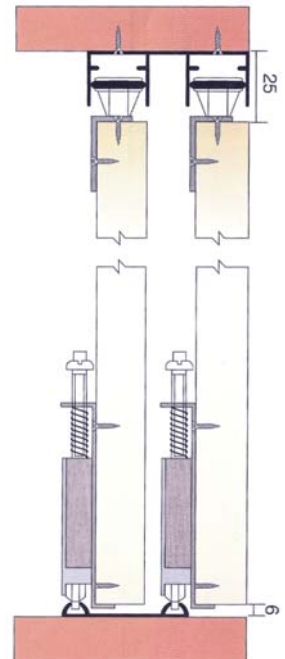

PNS 34 AY Üst Fren Klavuzlu Sistem Ray Kapak Mekanizması / Mechanism Groups

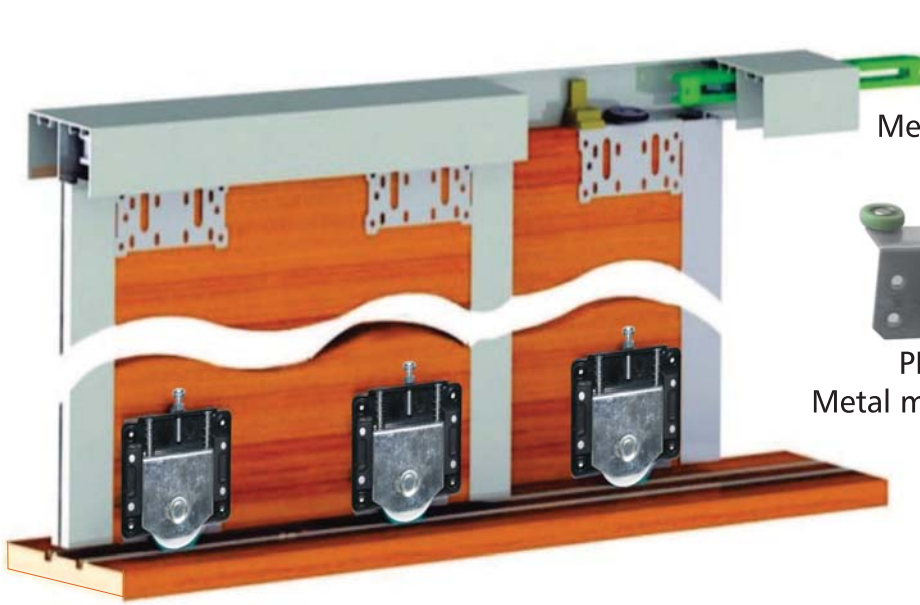

PNS 34 AY
Metal makaralı klavuz



PNS 34 AY
Metal makaralı klavuz



PNS 80 makara

Ray içi yavaşlatıcı



Çiftli Frenli Üst ray

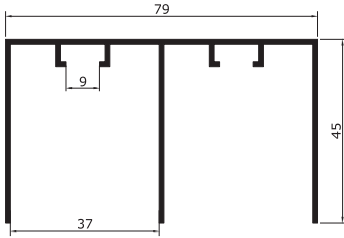

Çiftli Frenli Üst ray

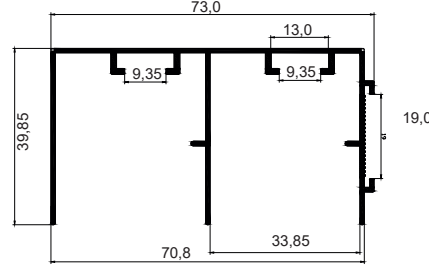

- * 80 kg ağırlığındaki sürgü kapaklarda kullanılır.
- * Kapak hareketi üstten frenli mekanizma alttan tekli makara ile sağlanır.
- * Kapakların kalınlığına göre tekli ve çiftli alüminyum ray seçenekleri mevcuttur.
- * 16-18-20-22 mm kalınlıklarındaki sunta kapaklara uygulanabilir.
- * Alt mekanizma poliamid kaplı çelik rulman tekeri ile çalışır.

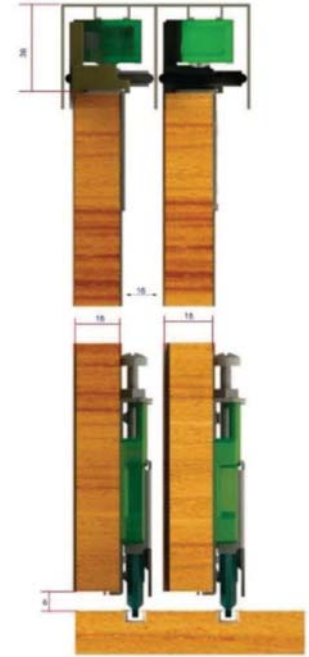

BC 1334 6

BC 1334 11

Çiftli Alt - Üst ray

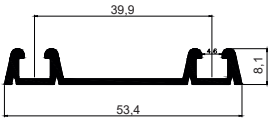

BC 1120 D

Çiftli Alt - Üst ray

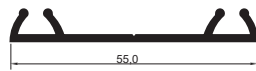

BC 1120 B

Tekli Alt - Üst ray



BC 1119

Tekli Alt - Üst ray

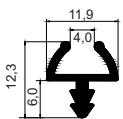

BC 1119 A

Tekli Alt - Üst ray

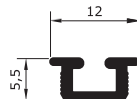

BC 1734 C

Tekli Alt - Üst ray

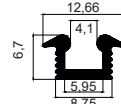

BC 1734 D

PNS 34 AY Üst Fren Klavuzlu Sistem Ray Kapak Mekanizması / Mechanism Groups

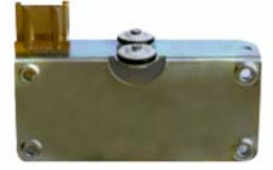
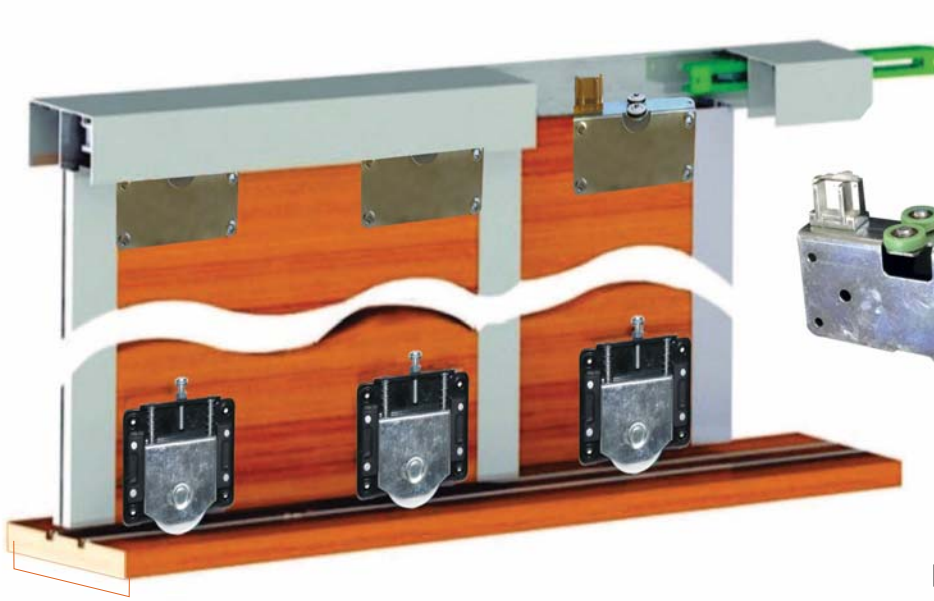

PNS 38 AY
Metal makaralı klavuz



PNS 80 makara

Ray içi yavaşlatıcı

Çiftli Frenli Üst ray

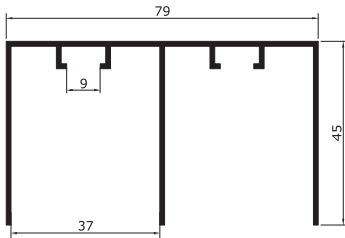

Çiftli Alt - Üst ray

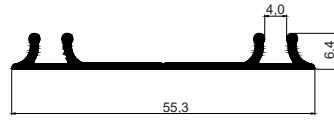

* 80 kg ağırlığındaki sürgü kapaklarda kullanılır.

* Kapak hareketi üstten frenli mekanizma alttan tekli makara ile sağlanır.

* Kapakların kalınlığına göre tekli ve çiftli alüminyum ray seçenekleri mevcuttur.

* 16-18-20-22 mm kalınlıklarındaki sunta kapaklara uygulanabilir.

* Alt mekanizma poliamid kaplı çelik rulman tekeri ile çalışır.

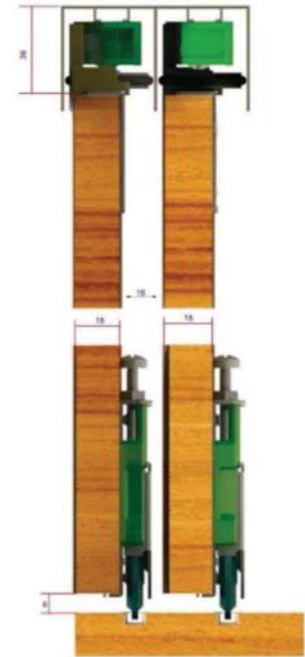

BC 1334 5

BC 1120 G

Çiftli Alt - Üst ray

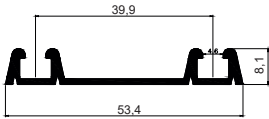

BC 1120 D

Çiftli Alt - Üst ray

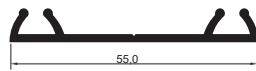

BC 1120 B

Tekli Alt - Üst ray



BC 1119

Tekli Alt - Üst ray

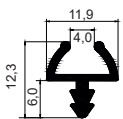

BC 1119 A

Tekli Alt - Üst ray

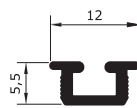

BC 1734 C

Tekli Alt - Üst ray

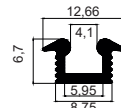

BC 1734 D

PNS 36 AY Üst Fren Klavuzlu Sistem Ray Kapak Mekanizması / Mechanism Groups

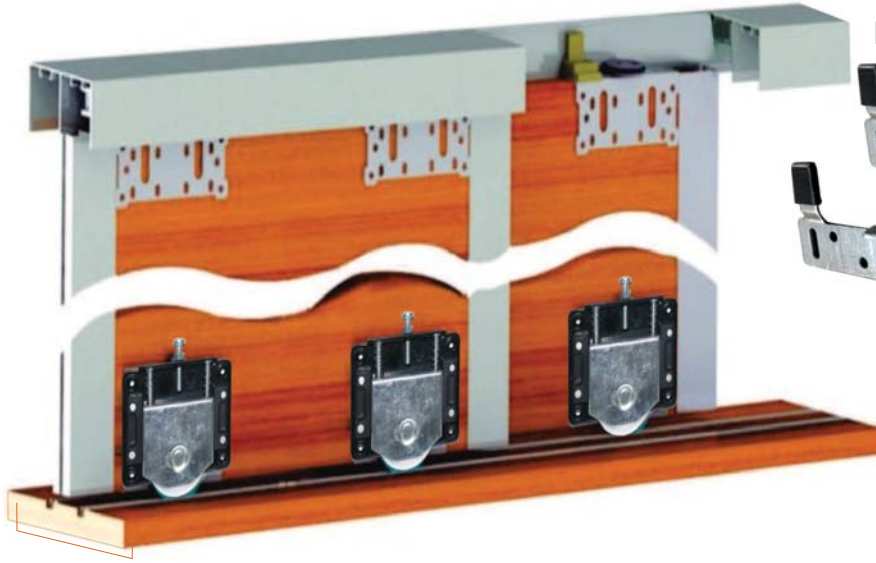

PNS 36 AY
Metal makaralı klavuz



PNS 80 makara



Ray içi yavaşlatıcı

Çiftli Frenli Üst ray

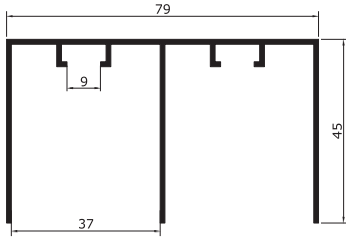

Çiftli Alt - Üst ray

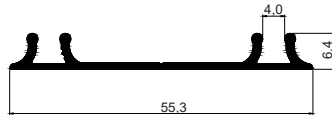

- * 80 kg ağırlığındaki sürgü kapaklarda kullanılır.
- * Kapak hareketi üstten frenli mekanizma alttan tekli makara ile sağlanır.
- * Kapakların kalınlığına göre tekli ve çiftli alüminyum ray seçenekleri mevcuttur.
- * 16-18-20-22 mm kalınlıklarındaki sunta kapaklara uygulanabilir.
- * Alt mekanizma poliamid kaplı çelik rulman tekeri ile çalışır.

BC 1334 7

BC 1120 G

Çiftli Alt - Üst ray

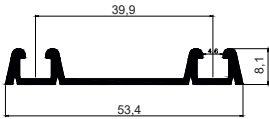

BC 1120 D

Çiftli Alt - Üst ray

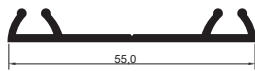

BC 1120 B

Tekli Alt - Üst ray

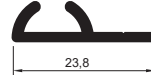

BC 1119

Tekli Alt - Üst ray

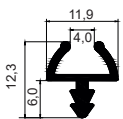

BC 1119 A

Tekli Alt - Üst ray

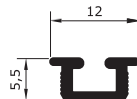

BC 1734 C

Tekli Alt - Üst ray

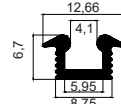

BC 1734 D

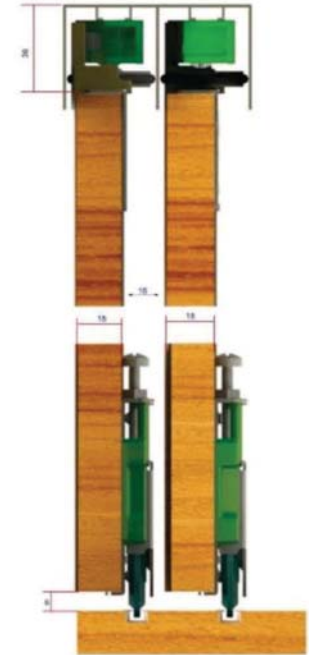

DAS 400 Sürme Kapak Mekanizması

/ Mechanism Groups



Çiftli Frenli Üst ray

Çiftli Alt - Üst ray

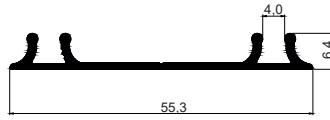
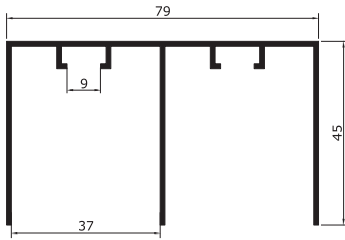

- * 90 kg ağırlığındaki sürgü kapaklarda kullanılır.
- * Kapak hareketi üstten frenli mekanizma alttan tekli makara ile sağlanır.
- * Kapakların kalınlığına göre tekli ve çiftli alüminyum ray seçenekleri mevcuttur.
- * 16-18-20-22 mm kalınlıklarındaki sunta kapaklara uygulanabilir.
- * Alt mekanizma poliamid kaplı çelik rulman tekeri ile çalışır.

BC 1334 / 7

BC 1120 G

Çiftli Alt - Üst ray

Çiftli Alt - Üst ray

Tekli Alt - Üst ray

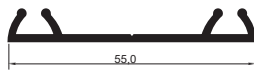
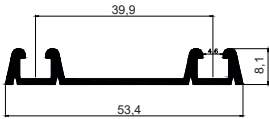

BC 1120 D

BC 1120 B

BC 1119

Tekli Alt - Üst ray

Tekli Alt - Üst ray

Tekli Alt - Üst ray

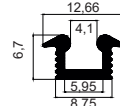
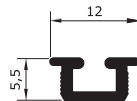
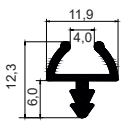

BC 1119 A

BC 1734 C

BC 1734 D



Suntalam Kenar Kapama Cumba Profilleri / Chipboard Wedged Edging Profiles

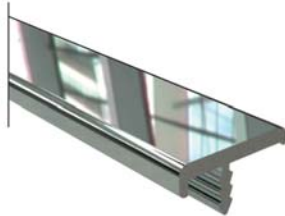
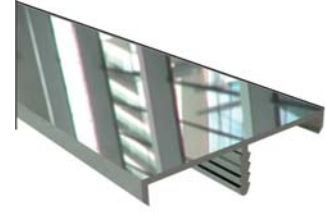
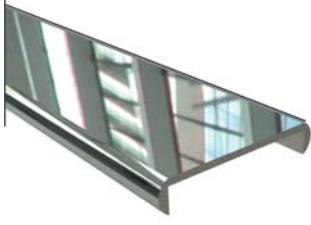

Bombe Kapak Çıtası / Curved frame profile

4 mm Suntalam /
Chipboard

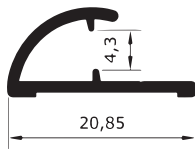

BC 6004 A

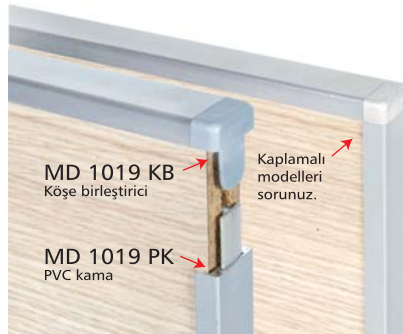

18 mm Suntalam / chipboard
* MD 1019 PK - MD 1019 KB
ile birlikte kullanılır

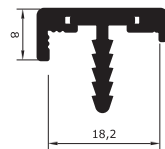

BC 1019



BOMBE KAPAK UYGULAMASI



Suntalam Kenar Kapama Cumba Profilleri / Chipboard Wedged Edging Profiles

16 mm Suntalam / chipboard 18 mm Suntalam / chipboard 19 mm Suntalam / chipboard 20 mm Suntalam / chipboard 22 mm Suntalam / chipboard

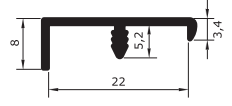
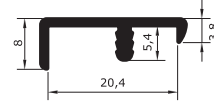
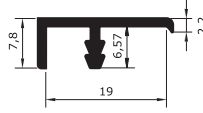
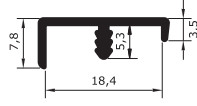
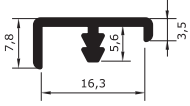

BC 1018 E

BC 1018

BC 1021

BC 1018 F

BC 1018 G

18 mm Suntalam / chipboard 18 mm Suntalam / chipboard 18 mm Suntalam / chipboard 36 mm Suntalam / chipboard

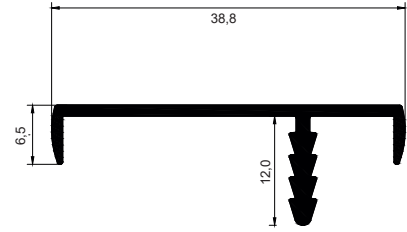
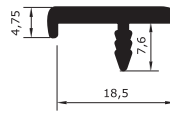
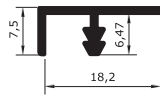
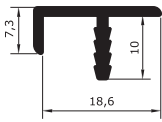

BC 1055

BC 1020

BC 1020 K

BC 1043 B

18 mm Suntalam / chipboard 18 mm Suntalam / chipboard 24 mm Suntalam / chipboard 42 mm Suntalam / chipboard

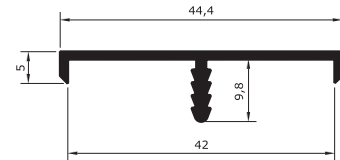
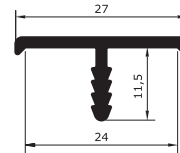
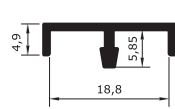
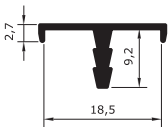

BC 1040

BC 1040 B

BC 1041

BC 1043



Suntalam Kenar Kapama Cumba Profilleri / Chipboard Wedged Edging Profiles

18 mm Suntalam / chipboard 18 mm Suntalam / chipboard 18 mm Suntalam / chipboard 16 mm Suntalam / chipboard 18 mm Suntalam / chipboard

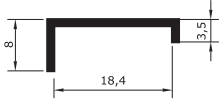

BC 1015

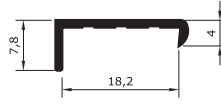

BC 1018 A

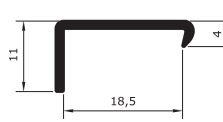

BC 1018 B

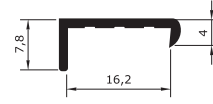

BC 1018 D

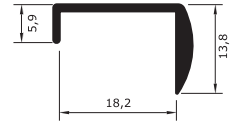

BC 1110

18 mm Suntalam / chipboard 18 mm Suntalam / chipboard 19 mm Suntalam / chipboard 19 mm Suntalam / chipboard 19 mm Suntalam / chipboard

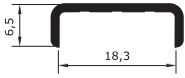

BC 1090



BC 1090 K



BC 1090 K

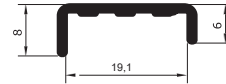

BC 1090 L

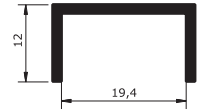

BC 1061 C

16 mm Suntalam / chipboard 22 mm Suntalam / chipboard 18 mm Suntalam / chipboard 18 mm Suntalam / chipboard 32 mm Suntalam / chipboard

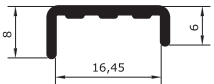

BC 1090 A

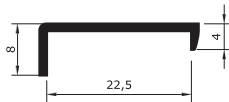

BC 1114

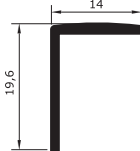

BC 1091

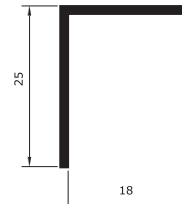

BC 1058

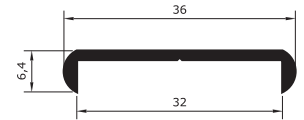

BC 1122 A

36 mm Suntalam / chipboard 42 mm Suntalam / chipboard 40 mm Suntalam / chipboard 45 mm Suntalam / chipboard

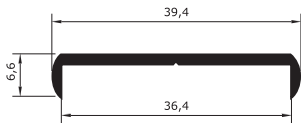

BC 1122

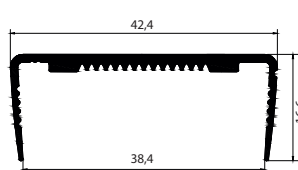

BC 1122 F

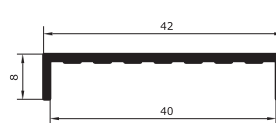

BC 1122 D

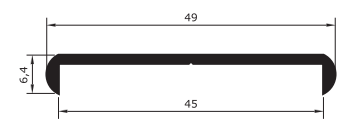

BC 1122 B

Tezgaah Süpürgelik ve Alın Kaplama Profilleri / Countertop Skirting and Face Coating Profiles

4 mm Suntalam / Cam
chipboard



BC 1058 A

6 mm Suntalam / Cam
chipboard

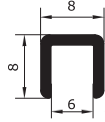

BC 1058 B

6 mm Suntalam / Cam
chipboard

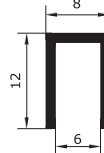

BC 1058 C

8 mm Suntalam / chipboard

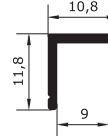

BC 1058 D

8 mm Suntalam / Cam chipboard

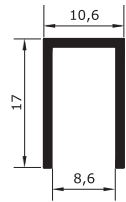

BC 1058 E

10 mm Suntalam / Cam chipboard

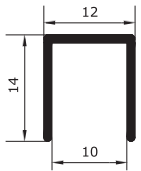

BC 1058 F

10 mm Suntalam / Cam chipboard

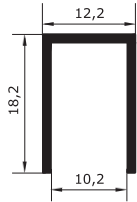

BC 1058 G

21 mm Suntalam / Cam chipboard

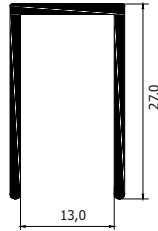

BC 1058 H

2 mm Suntalam / Cam chipboard

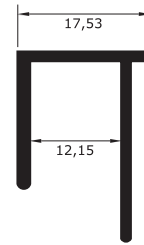

BC 1126

15 mm Suntalam / Cam chipboard

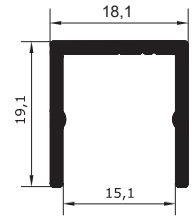

BC 1061 E

18 mm Suntalam / chipboard

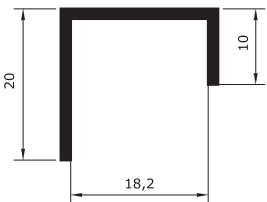

BC 1044

19 mm Suntalam / chipboard

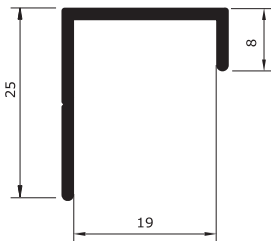

BC 1044 A

18 mm Suntalam / chipboard

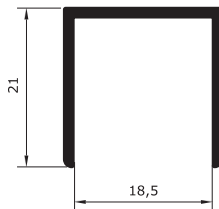

BC 1061

18 mm Suntalam / chipboard

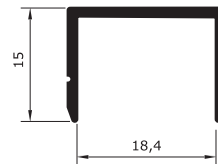

BC 1061 A

20 mm Suntalam / chipboard

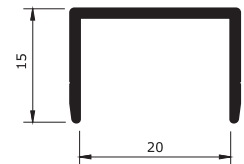

BC 1061 B



Sunta Birleştirme - Bitim - Dönüş - Derz Sistem Profilleri

Chipboard System Profiles For Ending, Cornering & Jointing

18 mm Suntalam /
chipboard

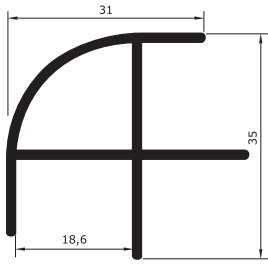

BC 0068

18 mm Suntalam /
chipboard

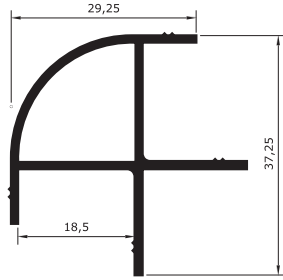

BC 0068 C

18 mm Suntalam /
chipboard

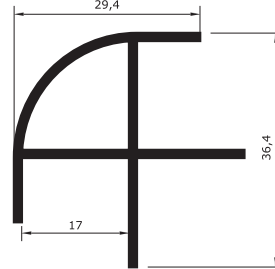

BC 0069

18 - 19mm Suntalam /
chipboard

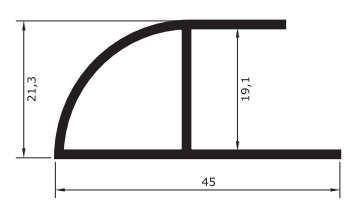

BC 0068 A

18 - 19 mm Suntalam /
chipboard

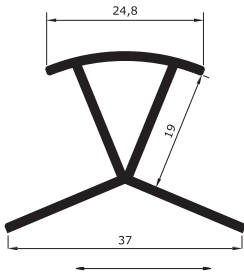

BC 0069 B

8 mm Suntalam /
chipboard

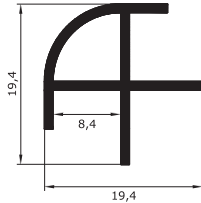

BC 0068 D

18 mm Suntalam /
chipboard

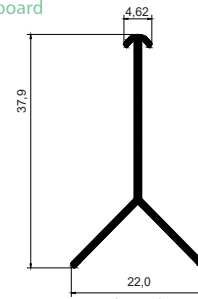

BC 0067

18 mm Suntalam /
chipboard

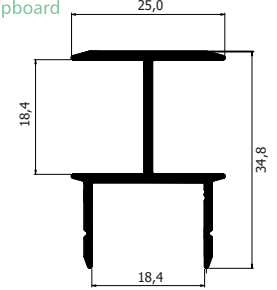

BC 0066

18 mm Suntalam /
chipboard

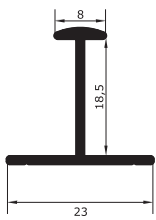

BC 0070 F

19 mm Suntalam /
chipboard

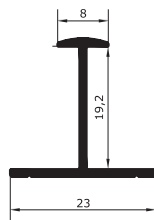

BC 0070 E

18 mm Suntalam /
chipboard

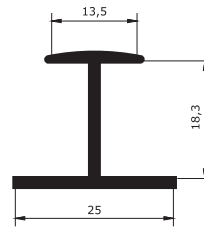

BC 0070 A

18 mm Suntalam /
chipboard

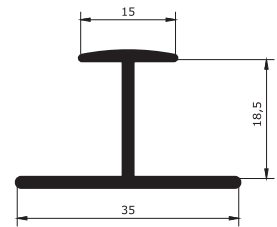

BC 0070

18 mm Suntalam /
chipboard

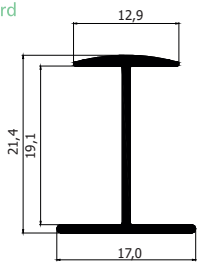

BC 0070 B

18 mm Suntalam /
chipboard

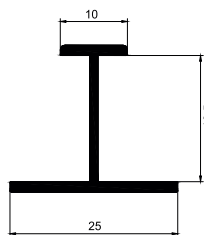

BC 0070 C

18 mm Suntalam /
chipboard

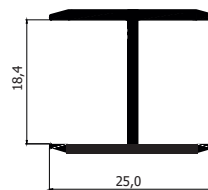

BC 0070 D

18 mm Suntalam /
chipboard

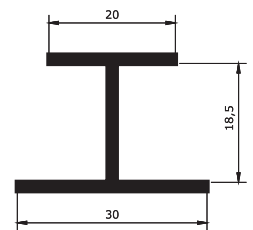

BC 0071

Sunta Birleştirme - Bitim - Dönüş - Derz Sistem Profilleri

Chipboard System Profiles For Ending, Cornering & Jointing

8 mm Sunta lam /
chipboard

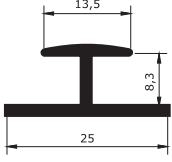

BC 0042

8 mm Sunta lam /
chipboard

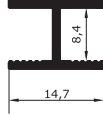

BC 0042 B

6 mm Sunta lam /
chipboard

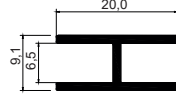

BC 0042 C

12 mm compact
birleştirme profili /
chipboard

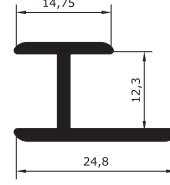

BC 0077

12 mm compact
birleştirme profili /
chipboard

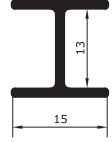

BC 0078

4 mm Sunta lam /
chipboard

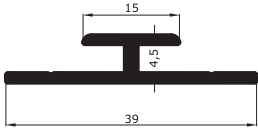

BC 0042 A

Derz profili /
jointing profiles

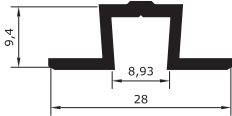

BC 0009

Derz profili /
jointing profiles

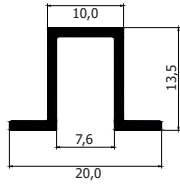

BC 0008

18 mm Sunta lam /
chipboard
4 mm Cam geçiş /
glass

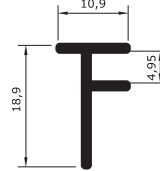

BC 1092

18 mm Sunta lam /
chipboard
4 mm Cam geçiş /
glass

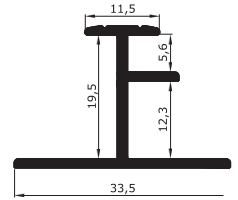

BC 1092 A

Cam çitisi

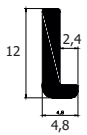

BC 1093

40 mm Gerdirme profili

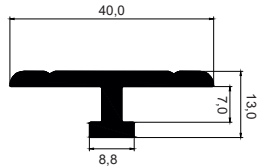

BC 1027 N

40 mm Gerdirme profili

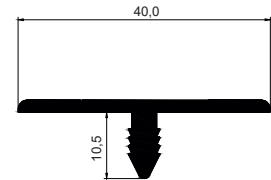

BC 1027 M



BC 1092



ÇP 0068 AT



ÇP 0068 AT

T Profiller - Suntalam Birleştirme Derz Profilleri / T Shaped Clipboard Joint Profiles

6 mm düz

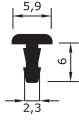

BC 1027 C

8 mm düz

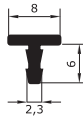

BC 1027 D

10 mm düz

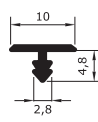

BC 1027 E

15 mm düz

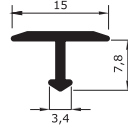

BC 1027 F

20 mm düz

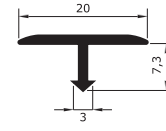

BC 1027 G

25 mm düz

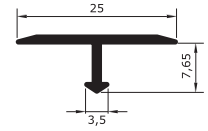

BC 1027 H

30 mm düz

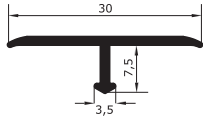

BC 1027 L

25 mm düz

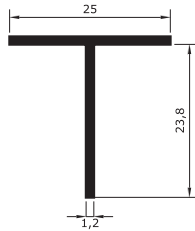

BC 1027 K

10 mm bombeli

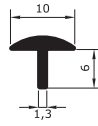

BC 1027 A

16 mm bombeli



BC 1027

16 mm bombeli

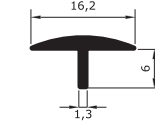

BC 1027 B

20 mm bombeli

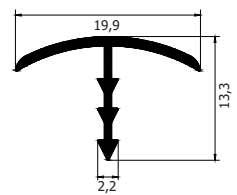

BC 1027 R

Dekorasyon Lama Profilleri / Decorational Flat bar Profil

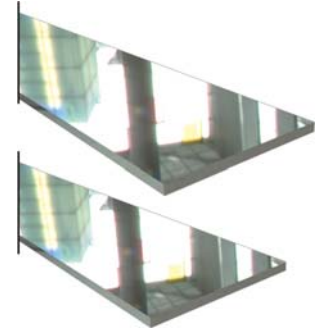
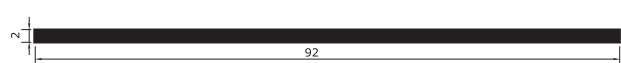
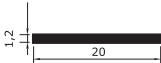
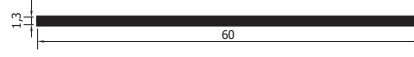
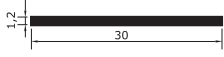
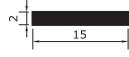
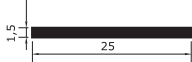

Dekorasyon Lama Profilleri / Decorational Flat bar Profil

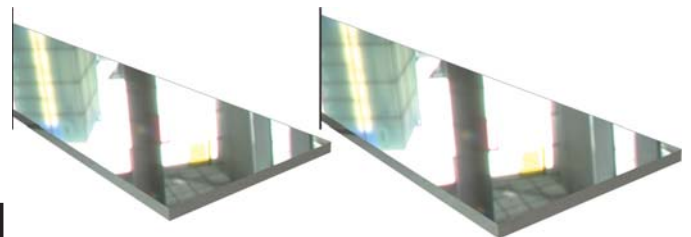
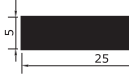
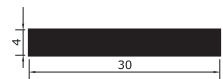
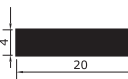

Kimyasal Parlak Kapak Çekmece Boy Kulpları / *Chemical Polish Frame & Drawer Handles*

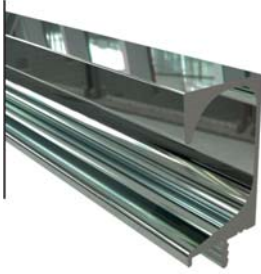
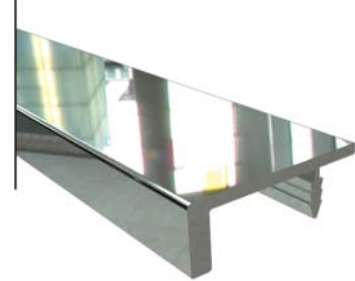
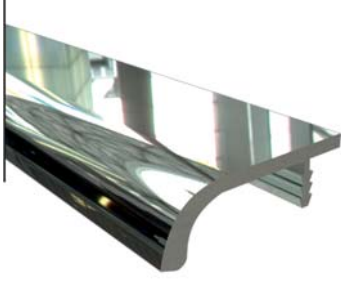

Kapak Çekmece Boy Kulpları / Cover Drawer Size Handles

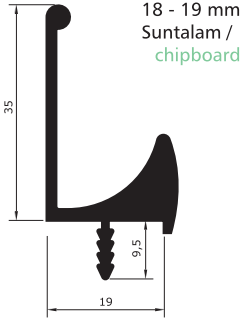

18 - 19 mm
Suntalam /
chipboard

BC 1029

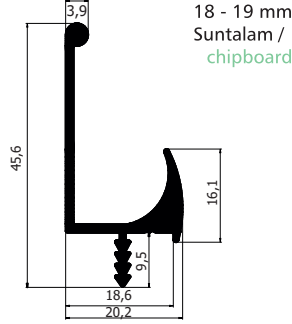

18 - 19 mm
Suntalam /
chipboard

BC 1029 A

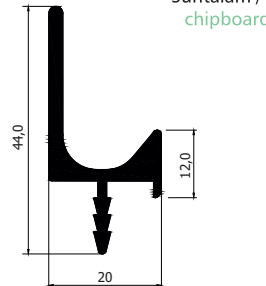

18 - 19 mm
Suntalam /
chipboard

BC 1029 B

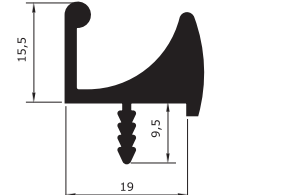

18 - 19 mm
Suntalam /
chipboard

BC 1039

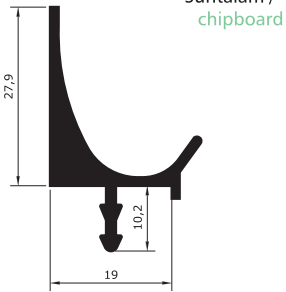

18 - 19 mm
Suntalam /
chipboard

BC 1028

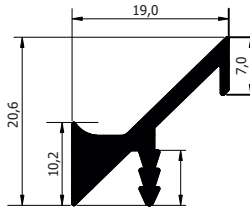

18 - 19 mm
Suntalam /
chipboard

BC 1028 A

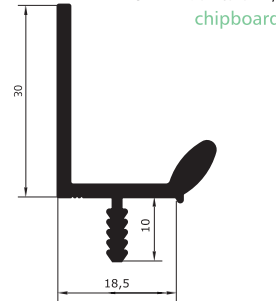

18 mm Suntalam /
chipboard

BC 1036

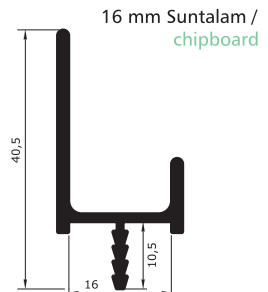

16 mm Suntalam /
chipboard

BC 1034

18 mm Suntalam /
chipboard

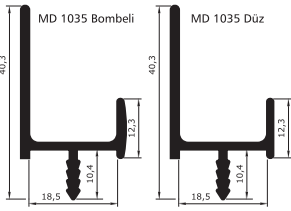

BC 1035

16 mm Suntalam /
chipboard

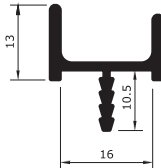

BC 1034 A

18 mm Suntalam /
chipboard

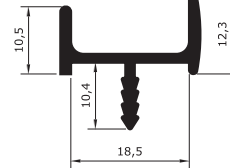

BC 1035 A

18 mm Suntalam /
chipboard

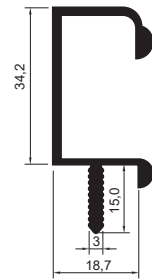

BC 1038 A

18 mm Suntalam /
chipboard

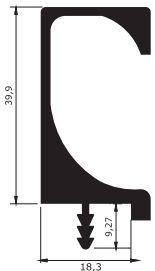

BC 1038

19 mm Suntalam /
chipboard

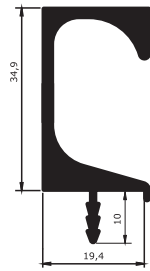

BC 1038 B

Menbram kapak kulp profili

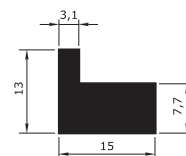

BC 1121

Menbram kapak
kulp profili

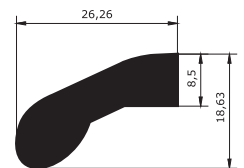

BC 1123

Kapak Çekmece Boy Kulpları / Cover Drawer Size Handles

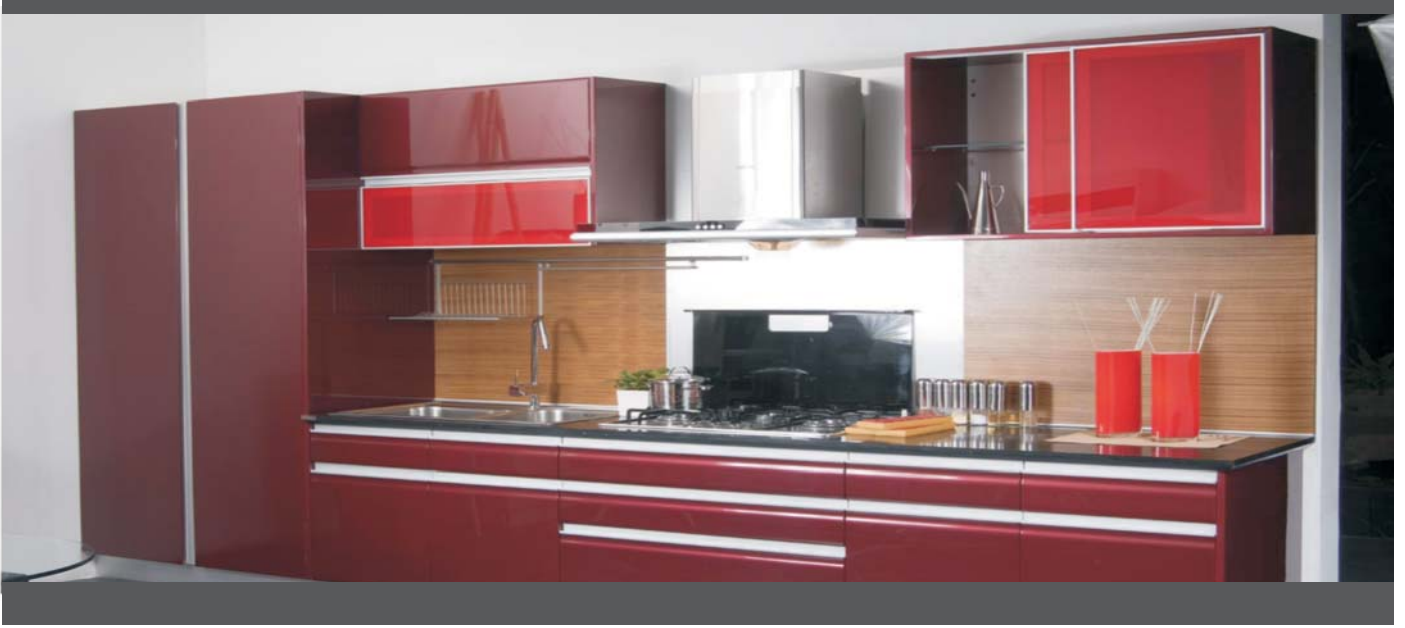

Kapak Çekmece Boy Kulpları / Cover Drawer Size Handles

18 mm Suntalam / F kulp
chipboard

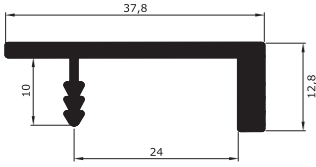

BC 1033

18 mm Suntalam / F kulp
chipboard

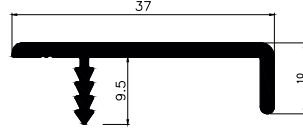

BC 1033 A

18 mm Suntalam / F kulp
chipboard

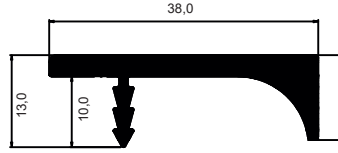

BC 1033 B

18 mm Suntalam / F kulp
chipboard

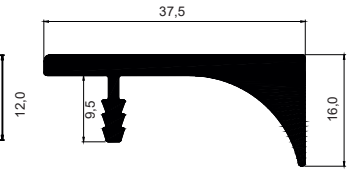

BC 1033 D

18 mm Suntalam / F kulp
chipboard

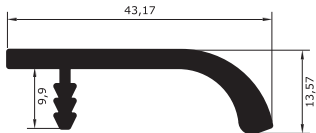

BC 1037

18 mm Suntalam / F kulp
chipboard

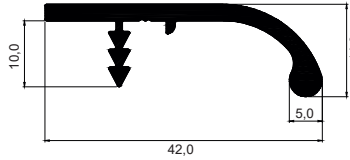

BC 1037 A

18 mm Suntalam / F kulp
chipboard

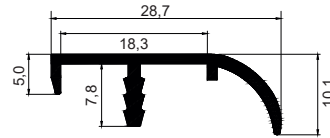

BC 1037 B

18 mm Suntalam /
chipboard

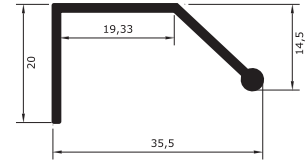

BC 1024

18 mm Suntalam /
chipboard

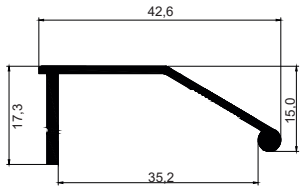

BC 1024 B

18 mm Suntalam /
chipboard

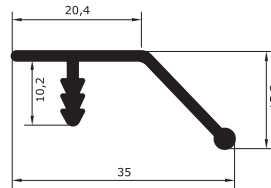

BC 1023 A

18 mm Suntalam /
chipboard

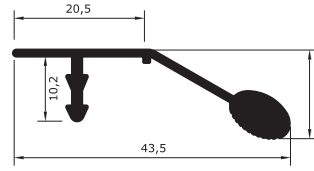

BC 1023

18 mm Suntalam /
chipboard

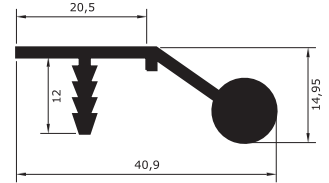

BC 1023 B

18 mm Suntalam /
chipboard

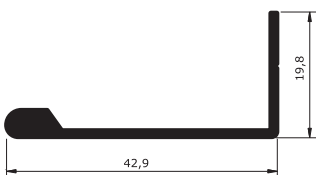

BC 1106

18 mm Suntalam /
chipboard

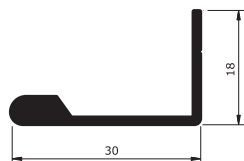

BC 1106 A

18 mm Suntalam /
chipboard

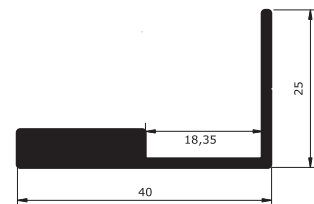

BC 1106 C

18 mm Suntalam /
chipboard

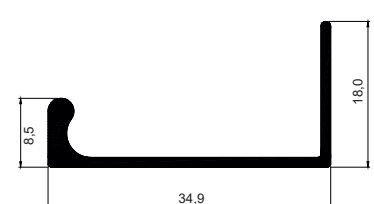

BC 1106 D

Kimyasal Parlak Kapak Çekmece Boy Kulpları / *Chemical Polish Frame & Drawer Handles*

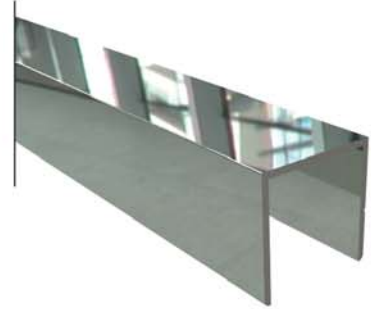
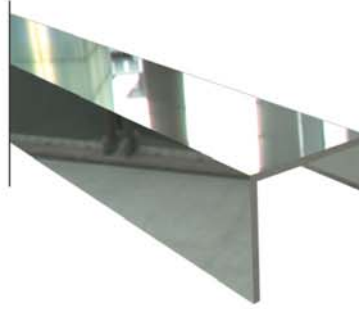
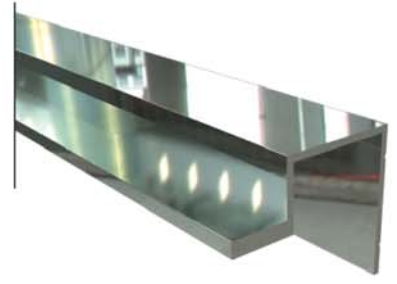
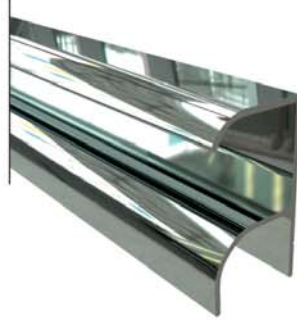

Kimyasal Parlak Kapak Çekmece Boy Kulpları / Chemical Polish Frame & Drawer Handles

19 mm Suntalam /
chipboard

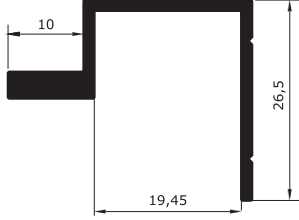

BC 1062

19 mm Suntalam /
chipboard

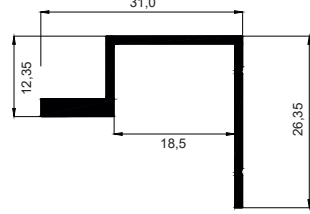

BC 1062 A

19 mm Suntalam /
chipboard

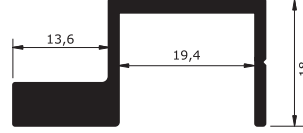

BC 1062 B

19 mm Suntalam /
chipboard

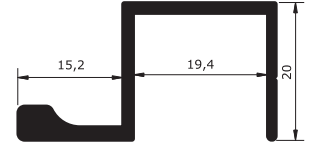

BC 1064 A

19 mm Suntalam /
chipboard

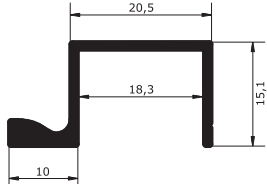

BC 1064 E

16 mm Suntalam /
chipboard

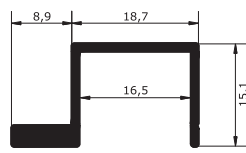

BC 1062 D

19 mm Suntalam /
chipboard

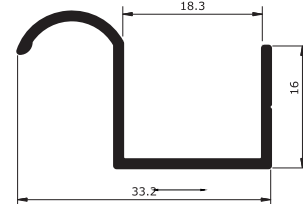

BC 1063

19 mm Suntalam /
chipboard



BC 1010

19 mm Suntalam /
chipboard

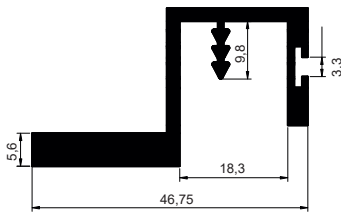

BC 1062 C

16 mm Suntalam /
chipboard

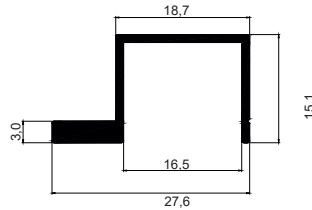

BC 1062 D

19 mm Suntalam /
chipboard

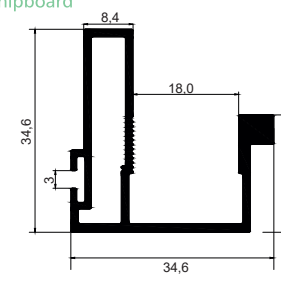

BC 1115

19 mm Suntalam /
chipboard

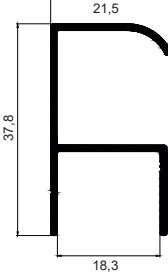

BC 1010 A

19 mm Suntalam /
chipboard

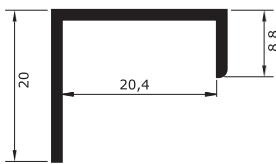

BC 1044

19 mm Suntalam /
chipboard

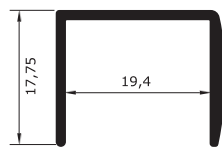

BC 1056 C

18 mm Suntalam /
chipboard

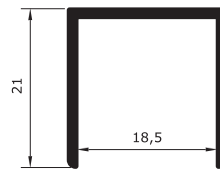

BC 1061

18 mm Suntalam /
chipboard

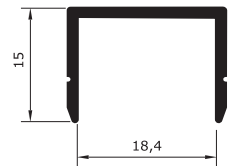

BC 1061 A

Kimyasal Parlak Kapak Çekmece Boy Kulpları / Chemical Polish Frame & Drawer Handles

18 mm Suntalam /
chipboard



BC 1071

18 mm Suntalam /
chipboard

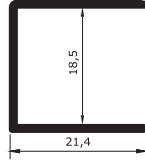

BC 1056

18 mm Suntalam /
chipboard

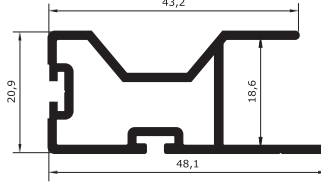

BC 1082

18 mm Suntalam /
chipboard

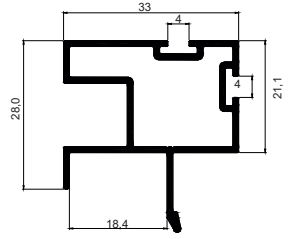

BC 1082 A

18 mm Suntalam /
chipboard

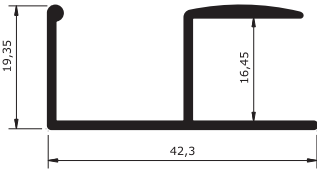

BC 1071 B

18 mm Suntalam /
chipboard

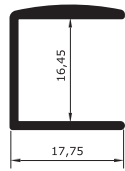

BC 1056 B

18 mm Suntalam /
chipboard

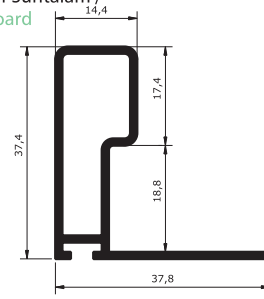

BC 1109

18 mm Suntalam /
chipboard

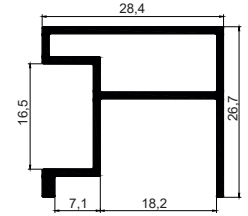

BC 1082 C

18 mm Suntalam /
chipboard

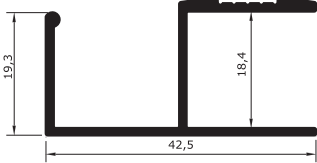

BC 1071 A

18 mm Suntalam /
chipboard

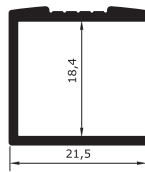

BC 1056 A

18 mm Suntalam /
chipboard

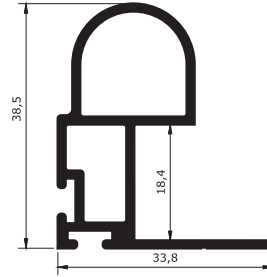

BC 1075

18 mm Suntalam /
chipboard

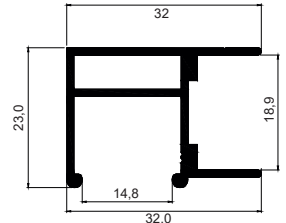

BC 1079 A

18 mm Suntalam /
chipboard

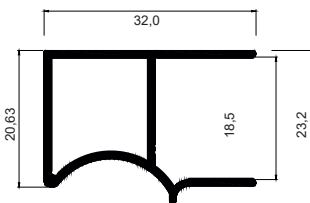

BC 1080

18 mm Suntalam /
chipboard

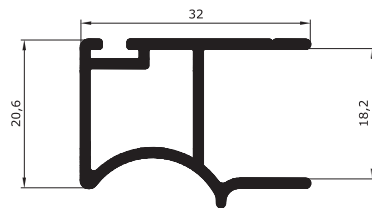

BC 1080 A

18 mm Suntalam /
chipboard

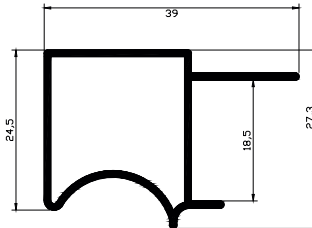

BC 1080 B

18 mm Suntalam /
chipboard

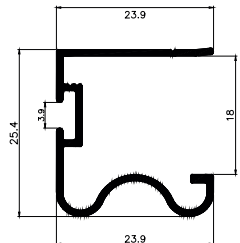

BC 1080 C

Kimyasal Parlak Kapak Çekmece Boy Kulpları / *Chemical Polish Frame & Drawer Handles*

18 mm Suntalam /
chipboard

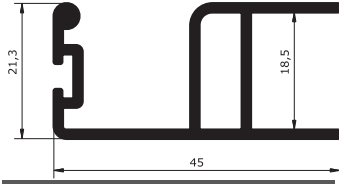

BC 1065

18 mm Suntalam /
chipboard

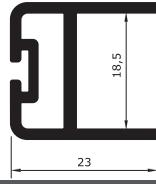

BC 1067

18 mm Suntalam /
chipboard

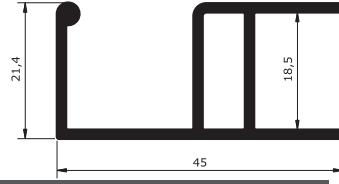

BC 1066

18 mm Suntalam /
chipboard

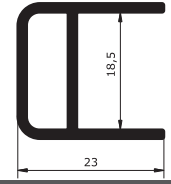

BC 1068

18 mm Suntalam /
chipboard

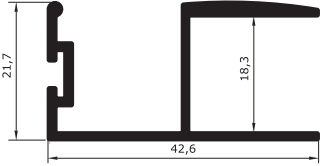

BC 1108

18 mm Suntalam /
chipboard

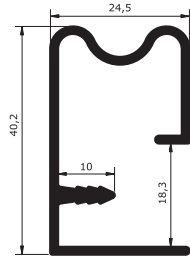

BC 1076

18 mm Suntalam /
chipboard

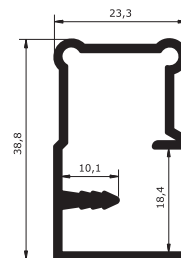

BC 1077

18 mm Suntalam /
chipboard

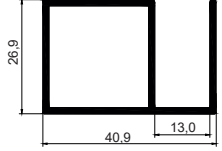

BC 1125

18 mm Suntalam /
chipboard

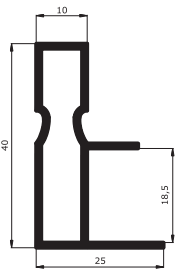

BC 1078

18 mm Suntalam /
chipboard

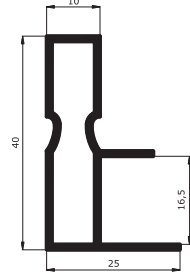

BC 1079

19 mm Suntalam /
chipboard

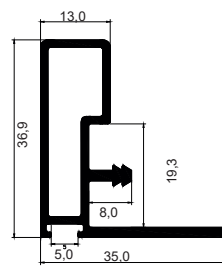

BC 1116

19 mm Suntalam /
chipboard

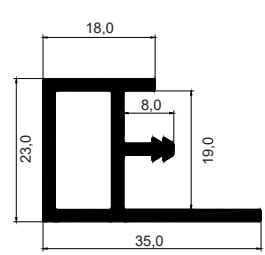

BC 1117

20 mm Suntalam /
chipboard

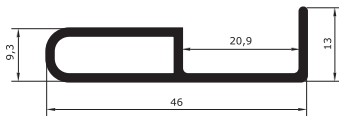

BC 1089

19 mm Suntalam /
chipboard

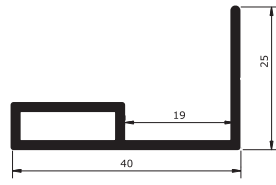

BC 1089 B

18 mm Suntalam /
chipboard

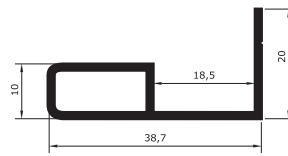

BC 1089 C

18 mm Suntalam /
chipboard

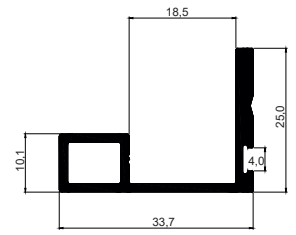

BC 1089 D

ÇAM İŞLEME



Dekoratif Ayna

Tezgah Arası Cam

Mutfak Tezgah Arası Cam Modelleri / Kitchen Interval Glass Models



Rall 9005



Rall 9003



3D Baskı

Tezgah Arası Cam

Mutfak Tezgah Arası Cam Modelleri / Kitchen Interval Glass Models

Rall 7046



Rall 9005



3D Baskı

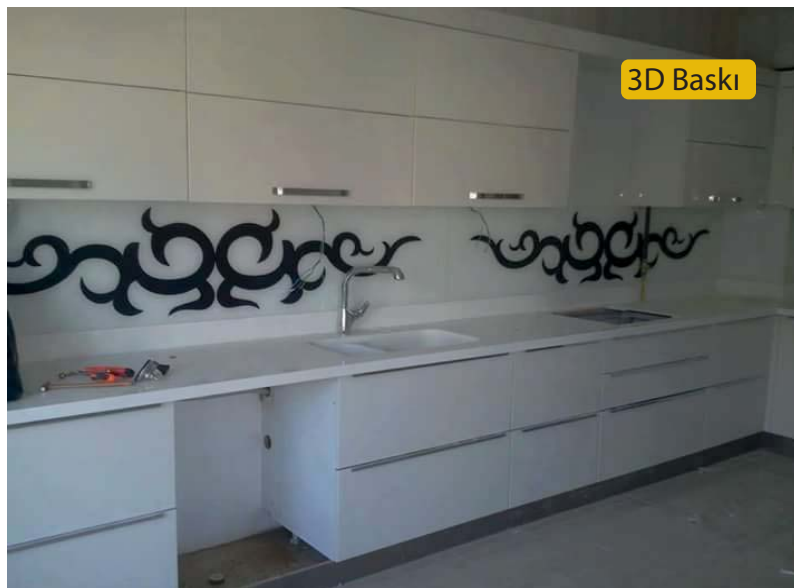

Cam Kapı Modelleri

Üstten Askılı Sürgü Cam Modelleri / Top Suspended Sliding Glass Models



Dekoratif Ayna Modelleri

Dekoratif Ayna Modelleri / *Decorative Mirror Models*



Makina Parkurumuz

Rodaj

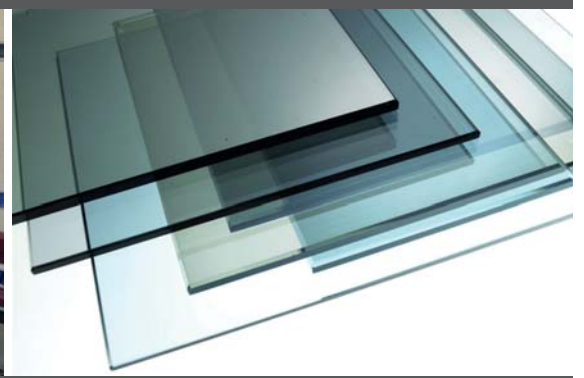

Bizote



Forma



Kanal & CNC KANAL



Dekoratif Cam

Dekoratif Cam Modelleri / Decorative Glass Models



Bambu



Başak

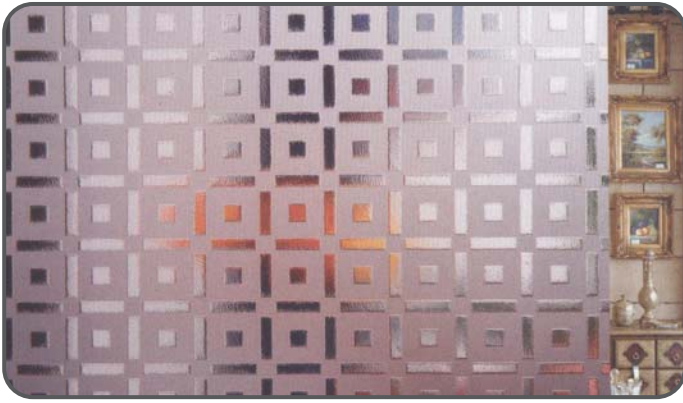

Boncuk

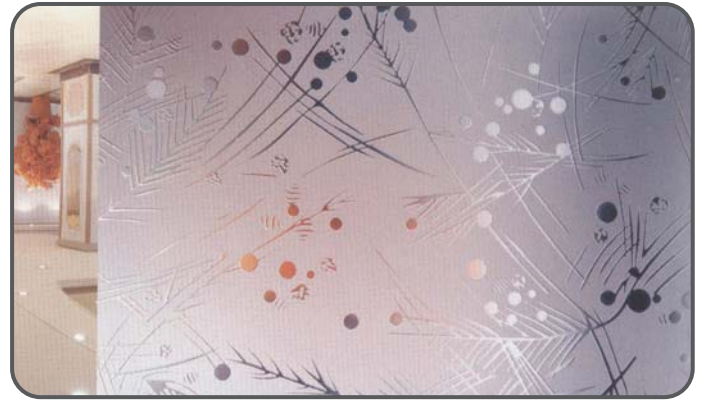

Çam

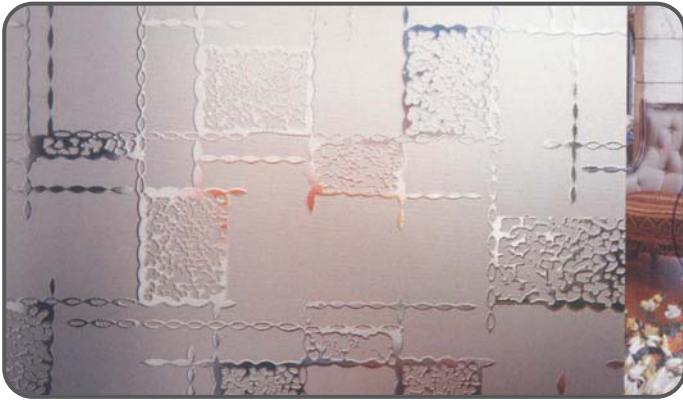

Damla

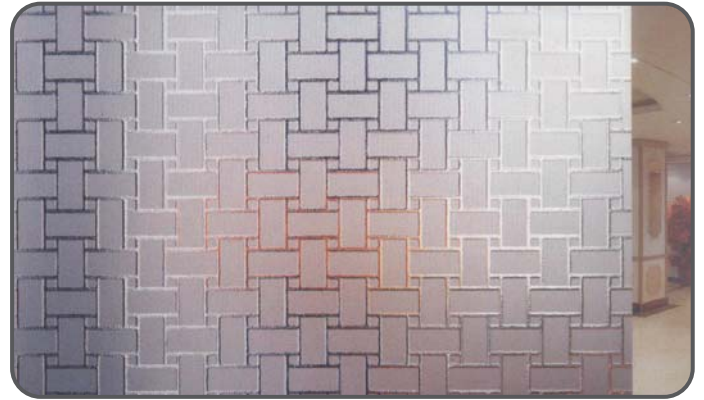

Hasır



Gül

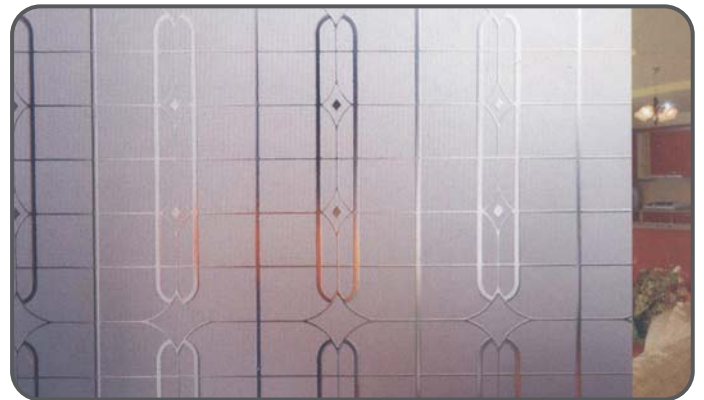

Kilim

Dekoratif Cam

Dekoratif Cam Modelleri / Decorative Glass Models

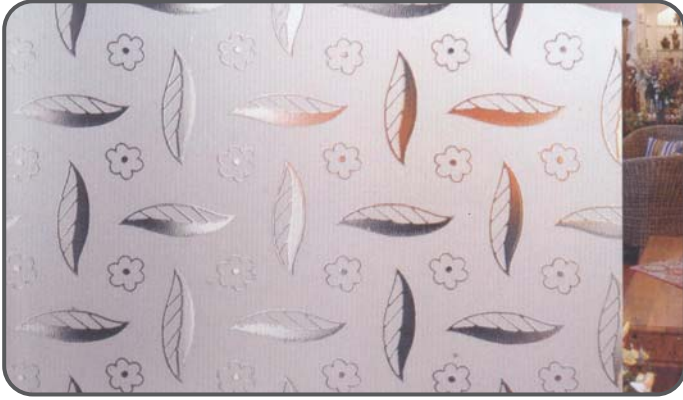

Yaprak



Zeytindali

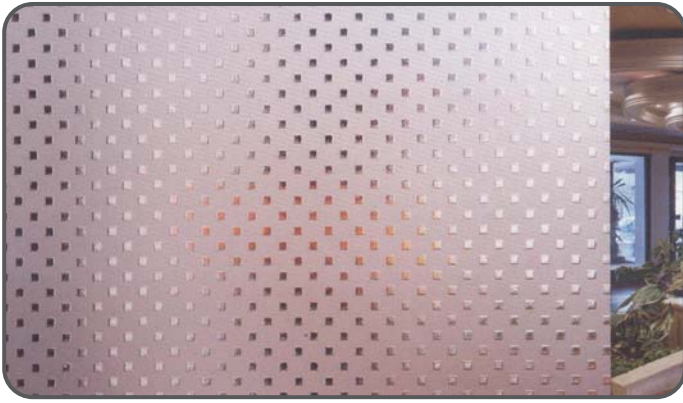

Punto

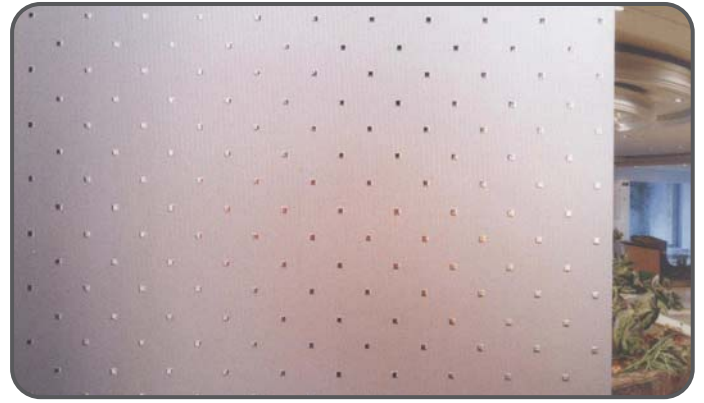

Pırlıtlı



Asma



İnce Çizgi

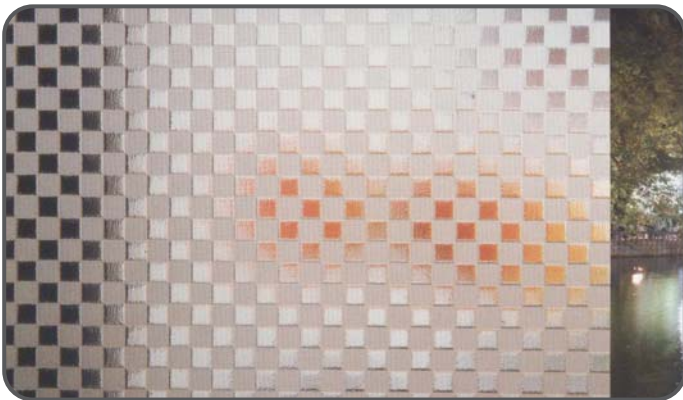

Mozaik



Labirent

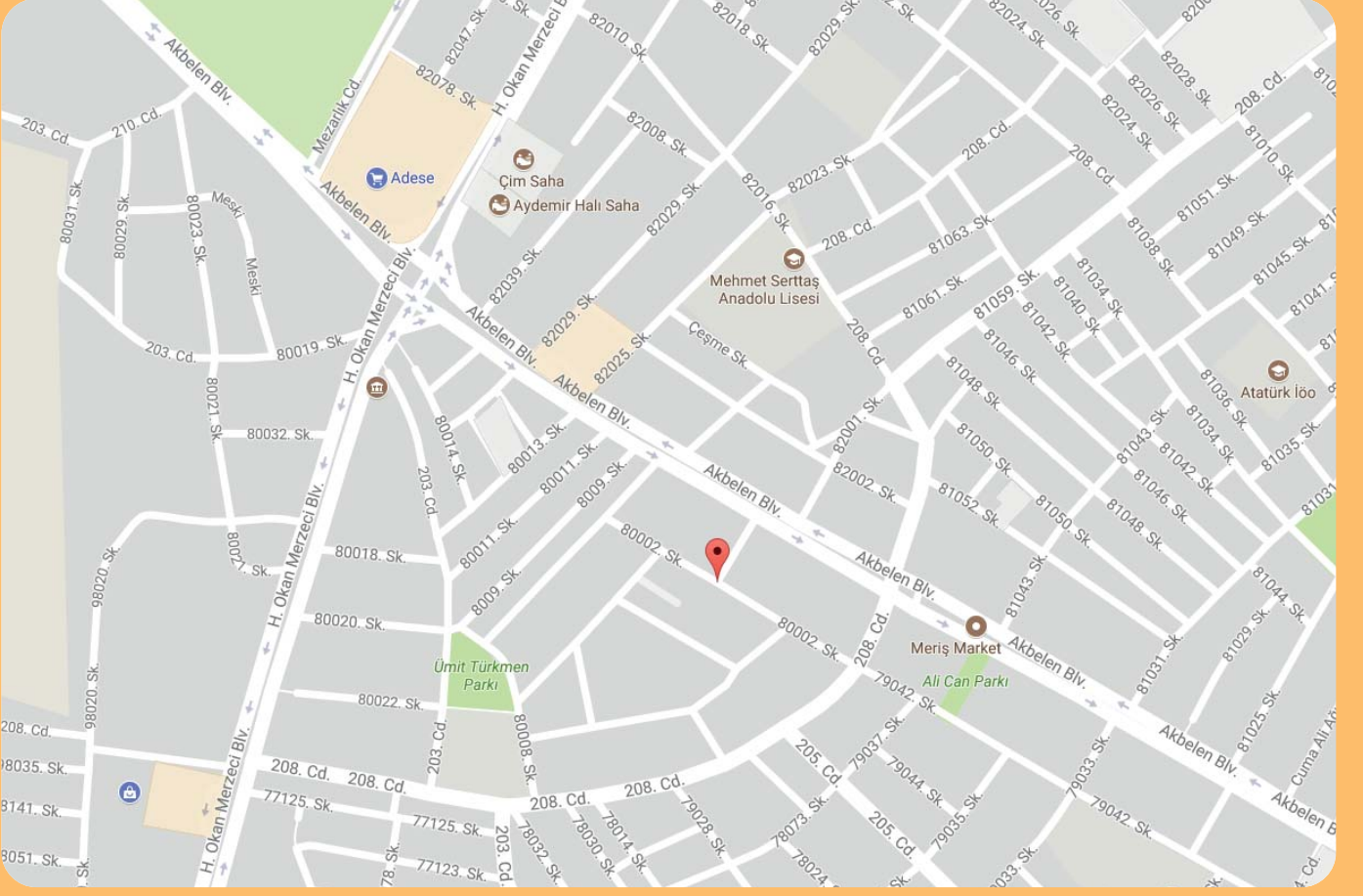

İLETİŞİM BİLGİLERİMİZ

☎ 0 324 320 31 36

📱 0 553 125 44 66 WhatsApp

📱 0 535 280 04 18 WhatsApp

📍 Portakal Mah. 80002 Sk Akgül Apt Altı No: 20 Toroslar/MERSİN

🌐 www.berkaycamaluminyum.com

✉ info@berkaycamaluminyum.com

📘 berkayaluminyum

📷 berkayaluminyum

🐦 berkayaluminyum

BERKAY

ALÜMİNYUM SÜRGÜ & KAPAK PROFİLLERİ

CAM



Tel: 0324 320 31 36 - Gsm: 0 553 125 44 66

Portakal Mah. 80002 Sk Akgül Apt Altı No: 20 Toroslar/MERSİN



www.berkaycamaluminum.com - info@berkaycamaluminum.com